

Fountain Creek - Manitou Springs, CO
Shryver Park Reach and Pond
Restoration Project

*A Project of the
Fountain Creek Restoration Committee
& the Pikes Peak Community Foundation*

Final Report



Prepared by:

Pete Gallagher, Fin-Up Habitat Consultants, Inc.
Eric Billmeyer, Rocky Mountain Field Institute
Steve J. Wood, Concrete Couch

Table of Contents:

Background.....p. 1

Budget.....p. 2

Fountain Creek and Shryver Pond Restoration Efforts.....p. 2

Project Revegetation and Volunteer Efforts.....p. 7

Shryver Pond Foot Bridge Construction.....p. 9

Project Goals/Objectives and Post Project Monitoring.....p.12

Appendix.....p.17

- Project Budget Spreadsheet and Notes
- Stream Restoration “As Built” Drawings
- Pond Restoration “As Built Drawing
- Pond Inlet Works “As Built” Detail
- Shryver Pond Bridge Engineering Plans
- Post Project Residual Pool Depth Monitoring Results
- Project Photograph Record
 - Heavy Construction
 - Volunteer Planting Days
 - Post Project “Huck Finn” Fishing Derby at Shryver Pond

Background:

Fountain Creek within the City of Manitou Springs has been dramatically altered throughout much of its length through channelization, construction of concrete retaining walls, and urban encroachment within the active floodplain. In 2006, a group of concerned citizens, business owners, and watershed advocacy organizations formed the Fountain Creek Restoration Committee (FCRC), to explore strategies to restore Fountain Creek and improve the fishery from “Arch to Arch” within the city limits of Manitou Springs. In the first year, the FCRC developed a master plan to provide a pathway to restoring the stream. Initial assessments of existing stream conditions were begun, and key segments of the stream were identified for restoration. Potential funding partners and stakeholders were identified, and fundraising began in 2007 for the first projects. In the fall of 2008, the FCRC completed their first stream restoration project, a segment of Fountain Creek within Soda Springs Park in downtown Manitou Springs, with funding assistance from the USF&WS Fishing is Fun Program, administered in the State of Colorado by the CO Division of Wildlife.

The next reach of Fountain Creek identified for restoration was located in Shryver Park, adjacent to the Manitou Springs Aquatics Center, near the eastern edge of town. The restoration effort would include improvements to Shryver Pond, the only pond within the Manitou Springs city limits. A detailed aquatic assessment of the Shryver Park stream reach and pond was conducted in May, 2008. The assessment indicated that the project reach exhibited generally poor quality aquatic habitat. Sedimentation from local erosion sources, as well as from sources upstream, were negatively impacting aquatic habitat within the reach. Stream bank stability was generally poor, particularly in the segment upstream of the Shryver Pond diversion structure. Other limiting factors to the fishery included poor quality pool habitat, and limited in-channel object cover in the low gradient riffles. Additional infrastructure problems included an exposed water line feeding the Aquatics Center, and a failing diversion structure feeding the pond. Analysis of the pond indicated that there was a potential dissolved oxygen problem, due in part to the poor function of the inlet. Additionally, considerable organic debris had accumulated over time, and the pond did not appear to sufficiently support cold water aquatic life for much of the year. An aquatic and riparian enhancement plan was developed for the stream and the pond, based on the findings of the assessment.



Pre-project Shryver Pond, showing the fill on the west side of the impoundment.

Budget:

A project budget was developed for the FCRC, and active fund raising in the community began immediately. Significant funds were pledged by the local chapter of Trout Unlimited to provide important “non-Federal” matching money for grant applications. With the encouragement and support of the Colorado Division of Wildlife, the FCRC and the City of Manitou Springs applied for funding for the Shryver Park Reach and Pond under the Colorado Water Conservation Board’s Colorado Watershed Protection Fund Grant Program, now known as the Healthy Rivers Fund. In August, 2008, the FCRC was notified that their request for \$49,999.00 was approved for use in 2009. Further local funding of \$15,000.00 was secured by the start of the project in the spring of 2009. The final cost of the Shryver Park project was \$110,392.20, including in-kind donations of time and materials of \$40,934.26. A detailed report of the project budget, including the in-kind donated costs, may be found in the appendix.

Stream and Pond Restoration – Fin-Up Habitat Consultants, Inc.

In early 2009, the FCRC and the City of Manitou Springs selected FIN-UP Habitat Consultants, Inc. to oversee the implementation of the project. FIN-UP, a local Manitou Springs aquatic consulting company, had previously conducted the initial assessments of the project reach, and developed the restoration plan in 2008. The FCRC and the City wanted to schedule the project for early spring of 2009, before the spring run-off began. It quickly became clear that this ambitious timeline for completion was not without risk, including the possibility of late spring snow or early run-off flows potentially impacting the project schedule, and concerns that the newly planted vegetation would not survive heavy summer recreation use, particularly if there were delays in scheduling the planting workdays.

A Request for Bids (RFB) was prepared by the City of Manitou Springs in February, 2009, for a heavy equipment contractor to provide equipment to install the habitat features outlined the enhancement plan, reconstruct and install the new diversion structure and pond inlet works, and dredge Shryver Pond. Several contractors attended the pre-bid meeting and walk-through, but only one formal bid was received by the City. The initial estimate for heavy equipment for the Shryver Park Reach and Pond project was \$28,080.00. The sole bid received was \$34,750.00. Negotiations ensued with the sole bidder, and an acceptable contract amount of \$28,750.00 was agreed to. In order to reach this negotiated contract price, several compromises needed to be made. The contractor agreed to include all of the clean-up tasks as part of his base bid, and the City would provide a loader for moving spoils from the pond to the awaiting dump truck for transport away from the site. The sole bidder, Chaparral Construction, LLC, from La Veta, CO was selected to provide equipment to the project. The company brought to the project an excellent record of previous stream work in the region, including similar habitat enhancement work on Fountain Creek in Colorado Springs and Manitou Springs, as well as the US Forest Service / Coalition for the Upper South Platte “Trees for Tout” projects on the South Platte River and Tarryall Creek.

With the heavy equipment contract coming in above the estimated budget, the FCRC sought to find savings on other aspects of the project, without significantly altering the

overall project goals and objectives. After the heavy equipment and dredging work, the next most complex part of the project involved the bank stabilization treatments and re-vegetation efforts. The Rocky Mountain Field Institute (RMFI), a local environmental education and restoration non-profit organization active in Colorado and Utah, provided outstanding expertise in the first Fountain Creek project in Soda Springs Park. The Soda Springs Park effort proved to be a good fit for RMFI's organization, and they brought to the table a considerable knowledge in ecological restoration, as well as a unique ability to provide opportunity for community involvement and participation in the project. The Rocky Mountain Field Institute would organize and implement the stream bank stabilization portion of the Shryver Park and Pond project, including identifying and acquiring the specific species of plants to be used. RMFI would also organize public volunteer work days to construct the bank stabilization features, and the re-vegetation of the stream banks and pond shoreline at the end of the project. This work would be done at cost, with the added benefit of significantly increasing the public participation in the project.



Pre-project pond diversion structure with 48" storm water culvert.

By late March, 2009, the final hurdles in putting together the project were complete, with a realistic plan to complete the work within the existing cash budget of \$65,000.00. Contracts were drawn up for approval by the Manitou Springs City Council, and construction was scheduled to begin on March 30, 2009. Two new head-gates, a custom catch basin, and 60 ft of 12" HDPE pipe were ordered for the project. Boulders were purchased from the Table Mountain Quarry south of Colorado Springs and hauled to the

project site the week prior to the scheduled start of the work. Additionally, workers from FIN-UP and the FCRC began the process of pumping ground water from Shryver Pond in preparation for dredging. Unfortunately, the weather failed to cooperate, and the project had to be postponed for one week due to heavy spring snow.

A small excavator (Komatsu PC78) and a bob-cat loader were transported to the worksite by Chaparral, LLC on April 6, 2009. The city of Manitou Springs provided a small mini excavator in addition to the Chaparral LLC equipment. Work began immediately, excavating the old pond inlet works, and preparing for construction of the new diversion structure. During the excavation of the old inlet pipe running underneath the bridge, the first major difficulty was discovered. Although we knew the old pipe ran underneath a major 16" sewer line, we had assumed that it was enclosed in a steel casing, which is the case where it emerges from the bridge foundation a few feet to the north. Unfortunately, while excavating by hand under the bridge, we discovered that the steel casing stopped at the bridge foundation, and the sewer line where our inlet pipe lay underneath consisted of fragile terracotta clay tile pipe of unknown stability. A quick conference with Brad Walters, City of Manitou Springs Operations Manager, and Richard Thomas, City Water and Sewer Dept. Director ensued, and it was agreed by all that the risk of excavating under this pipe was too great, and an alternative method of installation would need to be developed. The final "work-around" for this issue involved reducing the diameter of the new inlet pipe from the catch basin to the pond to 10". The new 10" inlet pipe would be sleeved through the existing 12" culvert, leaving this in place, and without disturbing the 16" sewer main. The inlet works supplier was able to deliver the necessary materials that afternoon, with a small re-stocking fee for the 12" culverts returned to the supplier.



Post-project pond Dual Head-gate diversion structure with 48" storm water culvert.

Concurrent with the construction of the new inlet works, work began on reconstructing the old diversion structure in Fountain Creek. The existing structure consisted of four telephone poles installed as a drop structure perpendicular to the stream channel, with the un-controlled pond inlet pipe extending upstream into the channel. This configuration was covered by a 48” storm water culvert extending over the inlet pipe and “shot-gunned” approximately 6 ft into the stream channel. The storm water culvert was cut approximately 10 ft back, exposing the old inlet pipe, which was removed from the site. The new custom catch-basin, with a dual head-gate clean-out assembly, was installed, and a large boulder cross-vane was constructed around the inlet works and tied into the existing drop structure. A small pool was constructed below the cross vane to provide fish passage through the diversion structure. Additionally, a hardened channel was constructed from the end of the storm water culvert to the stream channel convey run-off, protect the inlet pipe, and prevent head-cutting underneath of the culvert. The new diversion structure and inlet works required two days to complete construction.

Following completion of the inlet works and diversion structure, dredging of the pond commenced on April 8, 2009. This work required two days, and proved to be challenging, given the limitations of the size of excavation equipment used. Even with continual pumping, ground water infiltration continued to be an issue, and working conditions in the pond were less than ideal. Even with very wet conditions, however, we



Dredging Operations in Shyrver Pond. April 2009.

were able to remove a substantial amount of accumulated debris, and approximately 150 cubic yards of material were dredged from the pond and hauled to the City Cemetery for use as fill material for a renovation and enlargement project. Additionally, the pond was enlarged by excavating the entire western side of the pond at the location of the proposed new foot bridge. Average depth of the pond was increased from less than 3 feet to approximately 5 feet, and the maximum depth, near the outlet structure, was increased to greater than six feet.

Following the pond dredging, work commenced on the stream habitat enhancement portion of the project, beginning at the upstream boundary of the project reach. Boulder cross-vanes and micro-vortex in-channel object cover structures were installed at strategic locations along the stream, with boulder stream bank toe-slope structures installed to provide a foundation to support the later re-vegetation efforts. A total of fourteen pools were constructed or enhanced, and twenty-four in-channel object cover features were created along the reach. Detailed “as built” drawings of the stream work are included in the appendix to this document. Work on the in-channel structures and toe-slope features, continued downstream to the project boundary at the Garden of the Gods Place bridge, downstream of the Aquatics Center, and was completed by the afternoon of April 13, 2009. The following day, Chaparral LLC demobilized their equipment from the project site, ending the heavy equipment construction phase of the project.



Constructing a boulder cross vane in Fountain Creek. April 2009.

Stream and Pond Revegetation and Restoration – Rocky Mountain Field Institute

The Rocky Mountain Field Institute worked in partnership with the Fountain Creek Restoration Committee, Trout Unlimited, Fin-Up Habitat Consultants, and the City of Manitou Springs to complete the Shryver Park Bank Stabilization and Restoration Project. RMFI was tasked with stabilizing and re-vegetating banks adjacent to a 650' reach of Fountain Creek flowing through Shryver Park and the shoreline of Shryver Pond.

Pre-project preparation including surveying the project site, identifying appropriate wetland/riparian vegetation, identifying appropriate collection sites for willow and sedge mats, and procuring appropriate wetland/riparian seed mixes was completed during March of 2009. Outreach and volunteer coordination was then undertaken for the three project work days scheduled at the end of April.



RMFI volunteers placing rip-rap along the shoreline of Shryver Pond.

Project implementation began on April 24th, with additional volunteer days on the 25th and 26th. Over the course of the three days, 38 volunteers contributed 238 hours to this phase of the project. Work included the collection, preparation, and planting of willow sprigs and sedge mats as well as seeding wetland/riparian areas. Over 150 sedge mats were transplanted and 2,160 square feet of denuded park land was re-seeded using a special “low-grow” seed mix. Manitou Springs Park’s Department requested this seed mix which consists of Dwarf Fescue, Slender Hairgrass, and Roemer's Fescue so that the reseeded areas would more naturally blend in with the existing turf. Coconut and aspen



RMFI Volunteers planting sedges along Fountain Creek and seeding the pond island.

coir erosion control matting was then applied over the reseeded areas. To reduce erosion along the banks of the pond, volunteers moved over 16 tons of rock to cobble the banks and provide stability. A 6 foot long and 5 foot high retaining wall was also constructed along a section of the pond bank that was severely eroding. The retaining wall is now providing a stable platform that in the future is planned to be modified into a handicapped accessible fishing spot. RMFI also aided the youth volunteers who were working with Concrete Couch in the construction of rock “wing walls” to help protect the new bridge joining the park’s island to the park’s trail system.



Pikes Peak Youth Corps finish stream bank planting in early June 2009.

The final phase of the project for RMFI was completed in one day on June 4th. RMFI’s Pikes Peak Corps program for youth was utilized for this part of the project. The Pikes Peak Corps crew rehabilitated 3,600 square feet of denuded surfaces within the park utilizing the same “low grow” seed mix and erosion control matting as the earlier work days. To help stabilize the banks along the creek, 106 sedge transplants were collected and placed along a 340’ reach. In addition, 9.5 tons of rock was placed to provide an access route for stocking trucks to restock the pond with trout. Overall the team contributed an additional 80 hours to the project.

RMFI was very proud to be a part of the project and a special thank you goes out to all of our volunteers for their hard work and to Trout Unlimited who provided not only a great group of volunteers but a fantastic “chuck wagon” lunch. Final numbers for our part of the project are as follows;

- 5,760 square feet of denuded areas re-seeded and protected with erosion control matting.
- 256 sedge mats transplanted to stabilize 650’ of stream reach.
- 25.5 tons of rock used to protect banks and create a pathway for the stocking trucks.
- 48 volunteers (including the Pikes Peak Corps) contributing 318 hours that have an in-kind value of \$6,440 as per the 2008 Independent Sector calculation. Further information on calculating the value of volunteer labor can be found at their website. The URL is http://www.independentsector.org/programs/research/volunteer_time.html

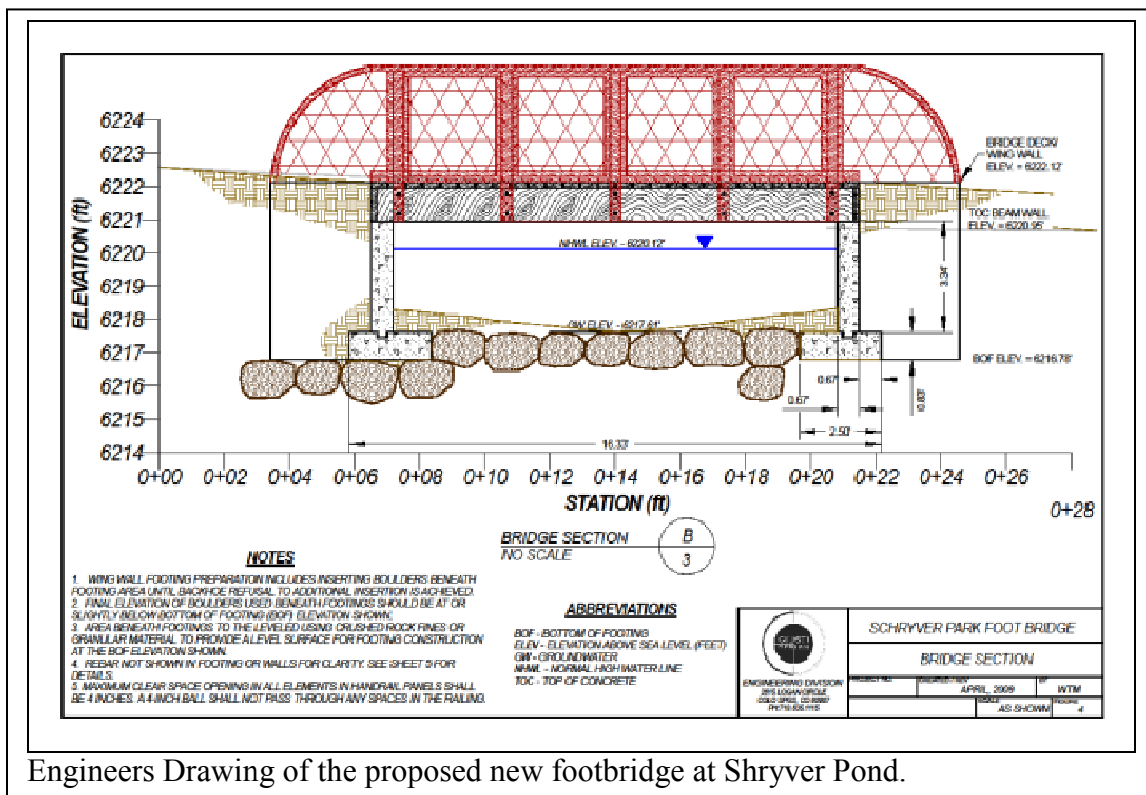

Engineers Drawing of the proposed new footbridge at Shryver Pond.

Shryver Pond Foot Bridge Construction – Concrete Couch

Concrete Couch, a local 501(c)3 not-for-profit community arts organization, worked with local teenagers, craftsmen, builders, and the City of Manitou Springs to build the new 14 foot pedestrian bridge on the west side of Shryver Pond in Shryver Park, Manitou Springs. We were very fortunate to be able to secure the professional services of a State licensed engineer for no cost. Without this expertise and assistance, it is highly unlikely that we could have succeeded in this effort. Detailed engineering drawings of the footbridge are included in the appendix to this document.

Our efforts to recruit volunteers for the project began in early March by holding informational meetings for prospective students at Manitou Springs High School.



Manitou Springs HS Students pouring bridge footings under the direction of CC staff.

Eighteen students signed up for the 10 two-hour session classes, which comprised the course, and covered every aspect of the bridge building process. Students would learn basic carpentry skills and how to build concrete forms, cut and attach rebar, pour and finish concrete, and learn basic metalworking skills. They would also learn a variety of artisanal skills, including the opportunity to work in small groups of just two students with an experienced metalworker and to create fused glass elements (both parts were incorporated into the beautiful handrail panels). They also would have the opportunity to create unique ceramic tiles for the wing walls, through out the park. Additionally students would learn methods for computing volumes of concrete, estimating material needs, some general hydraulic theories, and learn to put various principles of physics to work, and generally explore the experience of being construction workers.

Construction began immediately following the excavation of the west side of the pond by the heavy equipment crew, and continued for approximately 6 weeks through to completion and dedication of the structure in the first week of June, 2009. Our volunteers did all of the construction work, including framing the concrete forms, pouring the concrete, much of it by hand with shovels and wheel-borrows, and construction of the bridge deck and railings. Our volunteers created the welded iron decorative railings, as well as the art tiles that surround the



Pouring the Bridge Foundation Wing Walls.

structure. Much appreciated technical assistance was provided when necessary by the general project manager, City employees, and volunteers from the FCRC, as well as from frequent visits by our engineer to check on our progress.

The project relied heavily on local donations of materials and skilled labor, and generous support from the Manitou Springs Public Works Department. We started with a budget of \$7,500, which we received from the city of Manitou Springs, and used an additional \$1,796 of grant monies (Concrete Couch applied for, and received, a number of smaller grants to make up this amount). We also received significant in-kind and material support, from local businesses and skilled volunteers.



The finished footbridge constructed by high school students at Shryver Pond.

This public-private partnership, coupled with the educational component, made the project a short and long term success: the bridge is structurally sound and beautiful, and a generation of Manitou kids have a new source of pride in themselves and their community for years to come.



Project Goals/Objectives and Post Project Monitoring:

The goals and objectives of the Shryver Park Reach and Pond Restoration Projects, as outlined in the original assessment and restoration development document are stated below:

- Greater sediment transport efficiency, as measured by increased maximum pool depth, residual pool depth and total volume within newly constructed pools within the reach.
- 390 feet of eroding stream banks stabilized and revegetated (28% of the total stream banks in the reach).
- 1/3 Acre of improved in-stream and stream bank riparian habitat along 700 feet of Fountain Creek, including 11 Cross-Vanes to create or enhance 14 pool habitats, 1 J-Hook Rock Vane to provide additional pool habitat and to project the pond inlet structure, and 24 rock clusters to provide pocket water holding and feeding areas and velocity shelter within the riffle habitats of the reach.
- 1/4 Acre pond enhanced.
- Improved educational and recreational opportunities within the park, leading to the designation of Shryver Pond as the only "Kids Fishing Pond" in El Paso County.
- Create multiple fish viewing areas within the park. Install interpretive sign describing aquatic/riparian ecosystems and the enhancement efforts near the stone bridge.

Although it was necessary to adopt some minor changes to the specific treatments outlined in the Habitat Enhancement Plan, we are confident that we have achieved the overall goals and objectives of the project. Actively eroding stream banks throughout the project reach were treated and re-vegetated, flood plain function was improved and in-channel object cover and pool habitat for resident trout was dramatically increased. The goal of creating multiple fish viewing areas within the park met with nearly immediate success. Within a few days of completion of the heavy equipment work, resident brown trout were observed in the newly constructed pools and habitat features within the project reach. Trout can be easily spotted from the bridge leading to the Aquatics Center, as well as along shoreline of the newly enhanced pond. The new inlet works is performing as designed, and is has proven easy to operate and maintain. The newly restored pond maintains good D.O. levels throughout the summer (>6.0ppm), and supports trout throughout the habitat limited summer season. Indeed, our biggest challenge, at this point, will be addressing the increased fishing pressure and harvest at the pond. Fortunately, the Colorado Division of Wildlife has agreed to add the pond to their regular stocking schedule for 2010. The FCRC continues to work with the CDOW to develop voluntary restrictions to enhance fishing opportunities in Manitou Springs, and the option for designating the pond as a "Kids Only" facility is still under consideration. We hope to finalize these regulations sometime in early 2010.

Our responsibility to the project does not end when the last piece of equipment leaves the project site. Post-Project monitoring of the effectiveness of the treatments is critical to evaluate the success of the project, as well as to help us ensure that we are using treatments in future projects that have a good chance of success. The FCRC is working with local colleges and universities to assure that this monitoring effort can be completed without significant impact to resources available for future restoration projects. These post project monitoring efforts have already paid dividends, resulting in a small modification in the boulder cross-vane design that has dramatically improved scour and sediment transport through the newly formed pool habitats.



Huck Finn Day annual fishing derby at Shryver Pond, June 2009.

Immediately following construction, residual pool depths (RPD) were measured in each of the enhanced pool habitats by students from Colorado College. The results of this survey, are shown in the appendix to this document. RPD is a good measure of overwintering capacity in the stream, and can also help to monitor sediment deposition in the pools over time. Additionally, RMFI and the FCRC have established post-project photo-point monitoring sites to allow for easily repeatable monitoring over time of vegetation and stream bank treatments. In-channel habitat treatments will continue to be monitored in the short term by measuring the residual pool depth of these features, to determine whether adequate scour has been accomplished to keep these habitats from accumulating sediment.

In the longer term, we plan to accomplish monitoring of in-channel habitat features approximately one year following the installation of the project, again using Colorado College students participating in the Watershed Studies class taught by Profs. Howard Drossman and Miro Kummel. This work will include re-surveying the project reach using the same basin wide survey protocol used in the initial assessment, evaluating the changes to limiting factors identified in the initial assessment over a longer period of time. In addition to monitoring of the morphology of the stream, we are working with the Colorado Division of Wildlife to assess the resident biology in the reach. The FCRC and the CDOW have established two base-line reference electrofishing stations on Fountain Creek in Manitou Springs. Next summer, we hope to establish a electrofishing station within the Shryver Park reach to compare with the reference stations. Monitoring will continue periodically in the out years, and we hope to conduct a full assessment of both habitat and biomass five years following the project installation.

Since the completion of the restoration effort last spring, the project reach has experienced at least three flood events greater than the bank full design flow, including one event that was greater in excess of 270 cfs (approximately 3 times bank-full stage). We are generally pleased with the performance of the project during these flood flows, with the exception of the new diversion structure for the Shryver Pond inlet. While this structure is structurally sound and performing the function of getting water to the pond, we are not satisfied with the “fish-passage” aspects of this feature, and will be modifying future fish passage structures in our project reaches to function more effectively. Depending on the results of our monitoring of the new design, scheduled to be demonstrated in the Fields Park project in 2010, we may desire to revisit this diversion structure and implement the new modifications.



Shryver Pond Diversion Structure during the Sept 16, 2009 flood event.

The Soda Springs Park and Shryver Park restoration projects have brought a renewed interest within the community to preserve Fountain Creek as a valuable resource for our town and the region. Local community participation in the projects has been exemplary, and credit should be given to the Rocky Mountain Field Institute, Concrete Couch, and Trout Unlimited for recruiting these crucial resources. With the successful completion of the Soda Springs and Shryver Park Projects, the FCRC is pursuing further restoration efforts, as part of the master plan to restore the river from arch to arch. Assessments and planning have been completed on an additional three stream reaches, and funding has been secured to complete the next phase; the restoration of the remaining public reaches along Fountain Creek through the City of Manitou Springs, in 2010.



APPENDIX

PROJECT BUDGET

PROJECT “AS BUILT” DRAWINGS

POST PROJECT RESIDUAL POOL DEPTH MONITORING

PROJECT PHOTOGRAPHS

Shryver Park Reach and Pond Restoration Project

Final Project Budget

Prepared by Fin-Up Habitat Consultants, Inc. November 30, 2009

Line Item	Item Description	Total Cost	CWPF Share	FCRC Share	Other Funding	In-Kind Donation	In-Kind Donation Source
	Contracts						
1	Project Management: Fin-Up, Inc.	\$ 19,198.00	\$ 11,920.00 ¹		\$ 2,775.00 ²	\$ 4,500.00 ³	Fin-Up, Inc.
2	Heavy Equipment Contract: Chaparrel LLC	\$ 28,750.00	\$ 28,080.00	\$ 670.00			
3	Revegetation / Volunteer Coordination: RMFI	\$ 11,728.88	\$ 5,073.88 ⁴		\$ 206.00 ⁵	\$ 6,440.00	RMFI Volunteers (318 hrs)
4	Bridge Construction: Concrete Couch	\$ 25,812.00		\$ 7,500.00	\$ 1,796.00 ⁶	\$ 16,510.00 ⁷	CC (see break-out)
	Materials						
5	Pond Inlet Works (headgates, pipe, misc)	\$ 3,083.29		\$ 3,083.29			
6	Erosion Control Materials (EC Matting, Waddles, etc)	\$ 1,151.29	\$ 604.25 ⁴	\$ 543.04			
7	Boulders / Rip-Rap / Gravel	\$ 5,986.21	\$ 3,956.00 ^{8/4}	\$ 790.21		\$ 1,240.00 ⁹	City of Manitou Springs
8	Native Seed, Shrubs, other Vegetation	\$ 624.87	\$ 364.87 ⁴			\$ 256.00 ¹⁰	SWENT
	Equipment Rental						
9	Trash Pumps, Tamper, Roto tillers	\$ 589.43		\$ 121.17		\$ 468.26 ¹¹	City of Manitou Springs
10	BobCat Mini Excavator	\$ 2,880.00				\$ 2,880.00 ¹²	City of Manitou Springs
11	JD Wheeled Loader	\$ 1,080.00				\$ 1,080.00 ¹³	City of Manitou Springs
12	BobCat Loader	\$ 720.00				\$ 720.00 ¹⁴	City of Manitou Springs
	Manitou Springs / Other Expenses						
13	Floodplain Permit (PPRBA)	\$ 150.00		\$ 150.00			
14	Broken Telephone Line Repair (QWEST)	\$ 565.98		\$ 550.98 ¹⁵			
15	RPB bid package advertisement fee	\$ 15.25		\$ 15.25			
16	City Planning Staff and Steet Division Time Donated	\$ 5,000.00				\$ 5,000.00 ¹⁶	City of Manitou Springs
17	Interpretive and Etiquette Signage	\$ 1,467.00			\$ 1,200.00 ¹⁷	\$ 250.00	Jack Hunter (Sign Frame)
18	FCRC Volunteer hours during construction	\$ 1,215.00				\$ 1,215.00 ¹⁸	Tom Evans- FCRC
19	TU Chuckwagon (3 days)	\$ 375.00				\$ 375.00	Trout Unlimited

Total Project Costs	\$ 110,392.20	\$ 49,999.00	\$ 13,423.94	\$ 5,977.00	\$ 40,934.26
Distribution of Costs		45%	12%	5%	37%

Shryver Park Reach and Pond Restoration Project

Final Project Budget

Prepared by Fin-Up Habitat Consultants, Inc. November 30, 2009

Budget Notes:

- ¹ Fin-Up Habitat Consultants, Inc. Project Management Contract - 3/17/2009.
- ² Fin-Up Habitat Consultants, Inc. Pond Diversion/Inlet Design Contract - 2/13/2007 Paid by PARAB in 2007.
- ³ Value of donated labor and services - Stream Assessment/Design (\$2,500), Workday Supervision (\$750), post-project reporting (\$1250).
- ⁴ Total Paid to RMFI = \$7,000. Organization absorbed materials costs into Contract. These are broken out in Materials line items 6 -8.
- ⁵ RMFI Project Cost Overrun. This charge was identified by RMFI in Nov 2009 and submitted to FIN-UP. FIN-UP absorbed this cost overrun.
- ⁶ Bridge Materials Costs in excess of Concrete Couch Contract. Funds provided by PARAB (\$500), Manitou Springs Education Foundation (\$500), individual donations (\$796).
- ⁷ Bridge In-Kind Costs: Engineering (\$7,150), Volunteer Labor (\$8,020), Donated Materials (\$840), Donated Facilities by Manitou Springs Aquatic Center & Business of Art Center (\$500).
- ⁸ Boulder Cost Breakdown: CWPF share of boulders for stream project (\$2,999), RMFI paid rip-rap for pond shoreline as part of total RMFI cost (\$957).
- ⁹ Boulders & Gravel provided free of charge by City of Manitou Springs.
- ¹⁰ Value of Sedges (256 plants @ \$1.00/plant) harvested from the Camp Creek ditch in Colorado Springs. Permission granted by Colorado Springs Stormwater Enterprise.
- ¹¹ 3" Trash Pump Loaned to the project by the Manitou Springs Water Dept. for two weeks.
- ¹² BobCat Mini Excavator loaned to the project for 4 days. Cost based on market cost of \$90/hour.
- ¹³ Rubber Wheel Loader loaned to the project for loading of pond spoils, and delivery of gravel from City storage yard. Cost based on market cost of \$135/hour.
- ¹⁴ Bobcat loader and operator loaned to project for post project clean-up and bridge construction. Cost based on market cost of \$90/hour.
- ¹⁵ Cost to repair telephone line broken by City of Manitou Springs bobcat loader operator.
- ¹⁶ Estimate of City Staff time donated to the project. This included City Administator oversight, contracting, and City Street Division employee time for several phases of the project, including digging test pits for the Bridge engineer, providing resources from the City storage yard, and post-project clean-up of the construction site.
- ¹⁷ Interpretive / etiquette signs scheduled for installation in January 2010. Funds for signs will be paid directly by the FCRC.
- ¹⁸ Tom Evans, Fountain Creek Restoration Committee: 60 volunteer hours assisting in pond pumping and other implementation tasks.

1	2	3	4	RevNo	Revision note	Date	Signature	Checked
---	---	---	---	-------	---------------	------	-----------	---------



Garden of the Gods Place

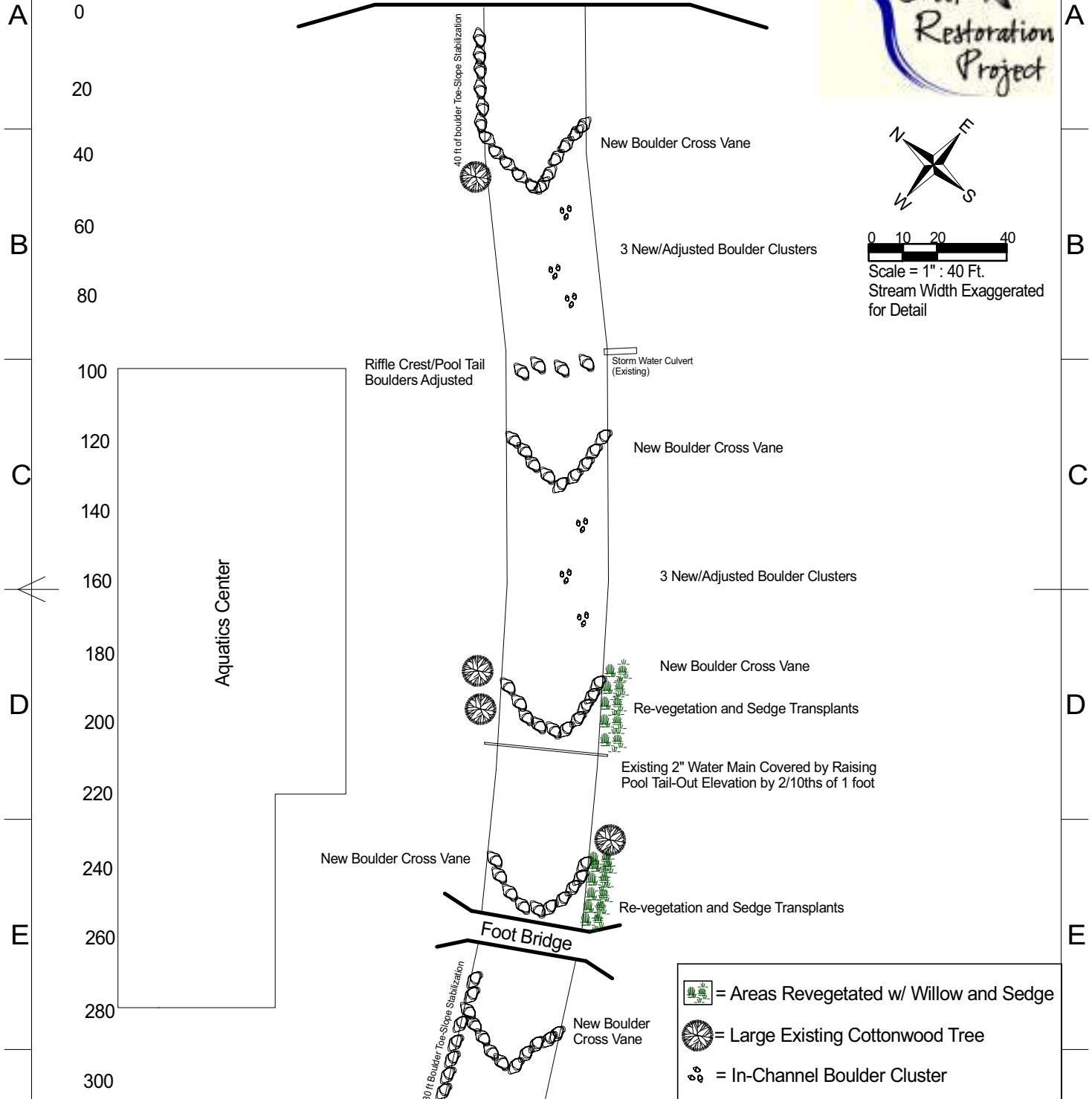

- = Areas Revegetated w/ Willow and Sedge
- = Large Existing Cottonwood Tree
- = In-Channel Boulder Cluster

Aquatic Habitat Restoration Plan			Prepared For FCRC	
Designed by P. Gallagher	Checked by	Filename Reach4a_v1.SKF	Date June 10, 2009	Scale 1" = 40 ft
Fin-Up Habitat Consultants, Inc. 220 Illinois Ave. Manitou Springs, CO 80829 (719) 332-2550		Manitou Springs - Fountain Creek Reach 4 As-Built Aquatic Restoration - Shryver Park		
Plan Drawing #1			Edition Ver. 1.0	Sheet 1

1 2 3 4

Date Signature Checked



0 10 20 40

Scale = 1" : 40 Ft.
Stream Width Exaggerated for Detail

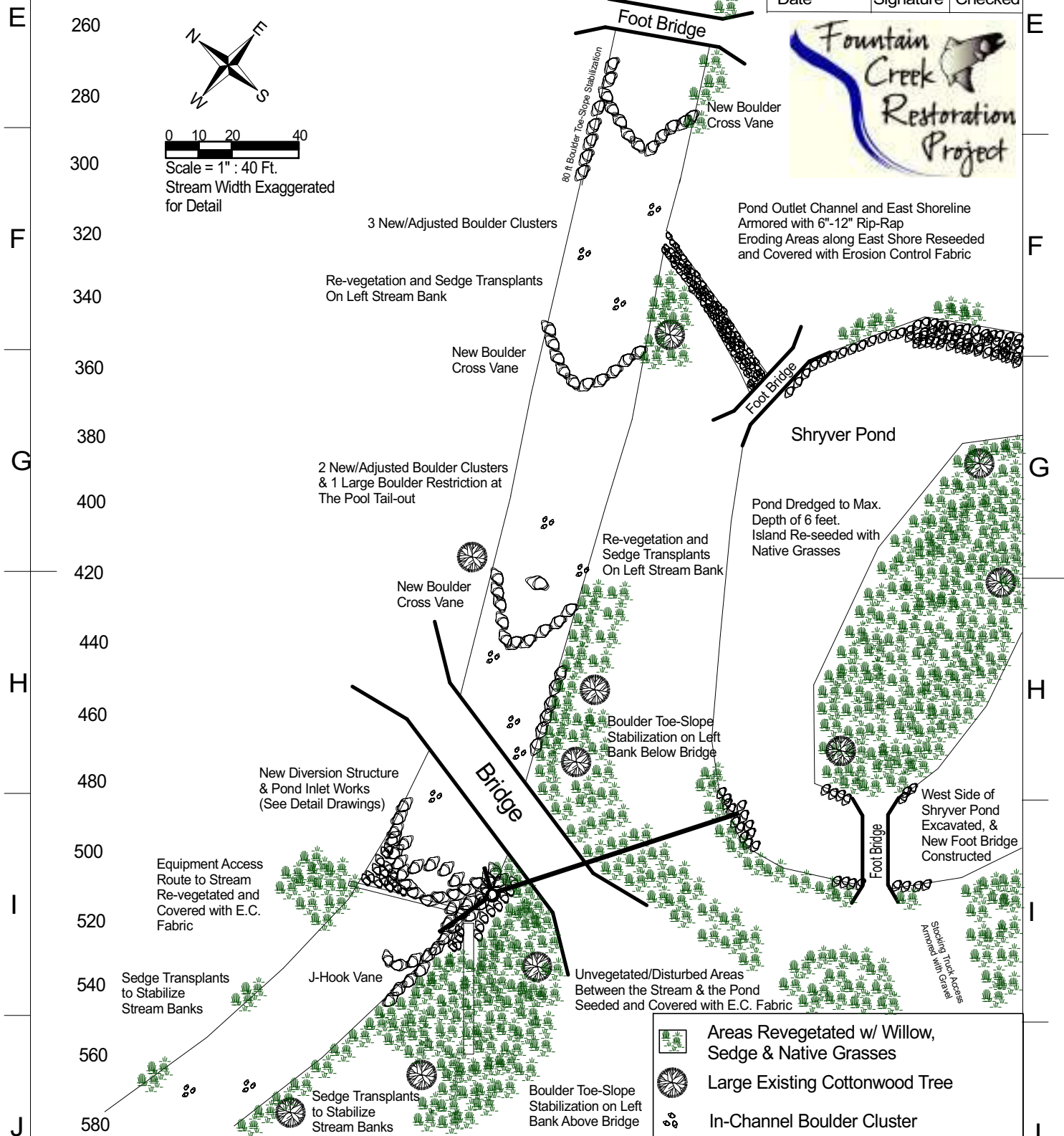

- Areas Revegetated w/ Willow, Sedge & Native Grasses
- Large Existing Cottonwood Tree
- In-Channel Boulder Cluster

Aquatic Habitat Restoration Plan			Prepared For FCRC	
Designed by P. Gallagher	Checked by	Filename Reach4b_v1.SKF	Date June 11, 2009	Scale 1"= 40 ft
Fin-Up Habitat Consultants, Inc. 220 Illinois Ave. Manitou Springs, CO 80829 (719) 332-2550			Manitou Springs - Fountain Creek Reach 4 As-Built Aquatic Restoration - Shryver Park	
Plan Drawing #2			Edition Ver. 1.0	Sheet 1

1 4

0	1	2	3
RevNo	Revision note	Date	Signature

H
I
J
K
L
M

A
I
J
K
L
M

420
440
460
480
500
520
540
560
580
600
620
640
680
700



0 10 20 40
Scale = 1" : 40 Ft.
Stream Width Exaggerated
for Detail

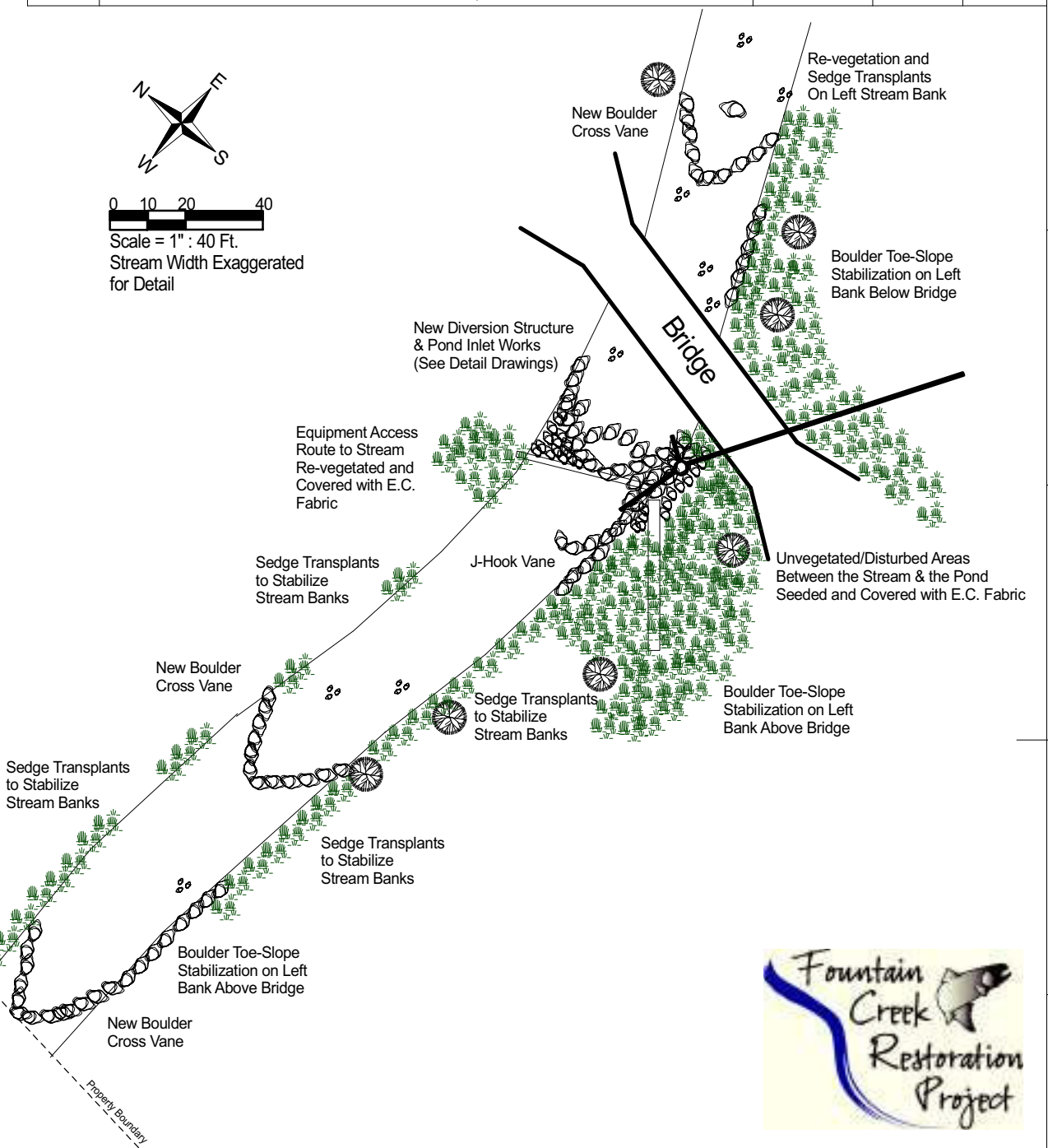

- = Areas Revegetated w/ Willow and Sedge
- = Large Existing Cottonwood Tree
- = In-Channel Boulder Cluster

Aquatic Habitat Restoration Plan		Prepared For FCRC	
Designed by P. Gallagher	Checked by	Filename Reach4c_v1.SKF	Date June 11, 2009
Fin-Up Habitat Consultants, Inc. 220 Illinois Ave. Manitou Springs, CO 80829 (719) 332-2550		Manitou Springs - Fountain Creek Reach 4 As-Built Aquatic Restoration - Shryver Park	
Plan Drawing #3		Edition Ver. 1.0	Sheet 1

0

3

1	2	3	4
RevNo	Revision note	Date	Signature
			Checked

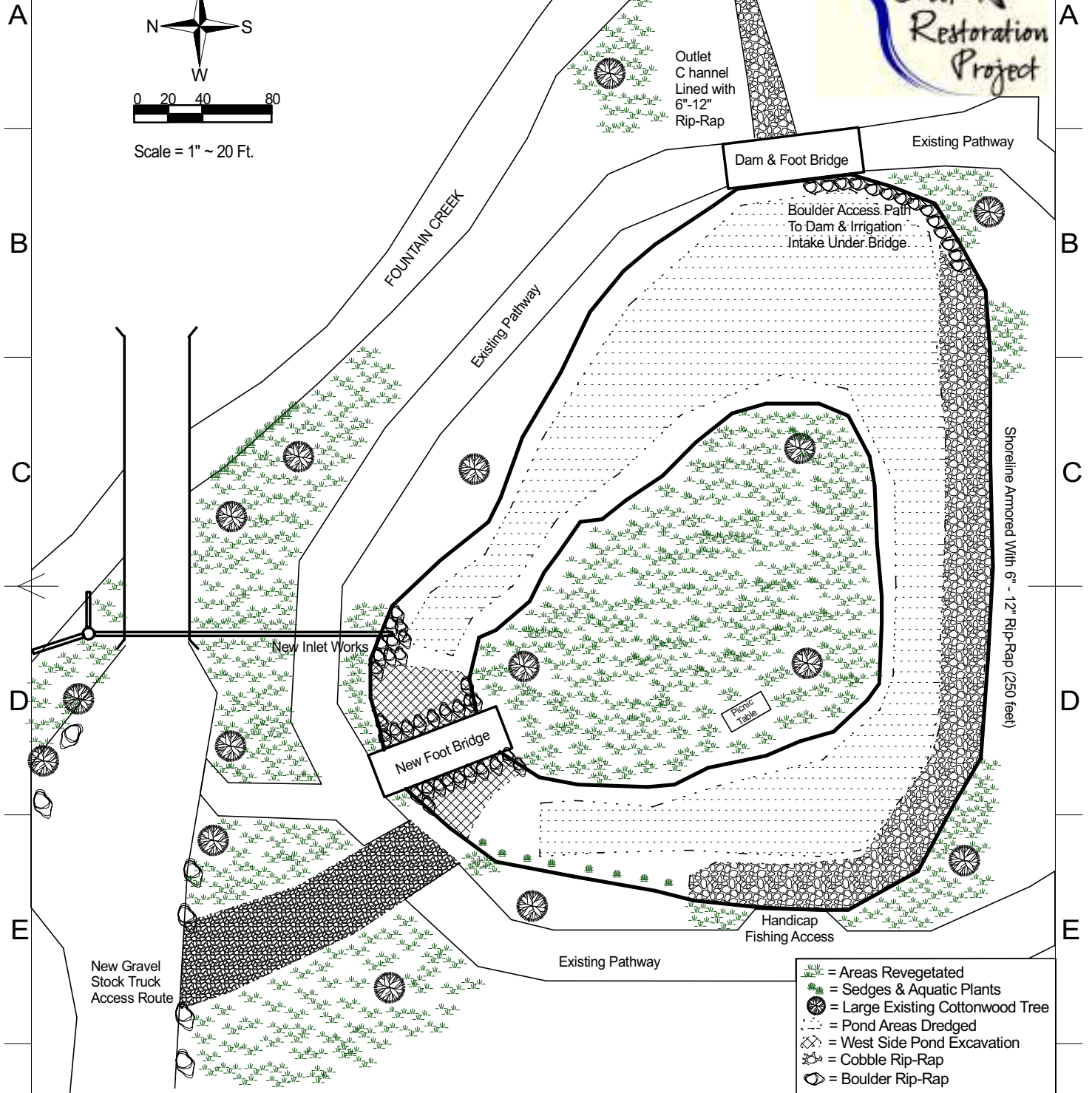
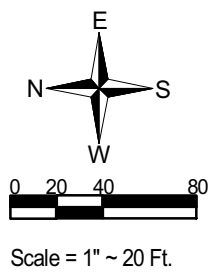

- = Areas Revegetated
- = Sedges & Aquatic Plants
- = Large Existing Cottonwood Tree
- = Pond Areas Dredged
- = West Side Pond Excavation
- = Cobble Rip-Rap
- = Boulder Rip-Rap

Aquatic Habitat Restoration Plan		Prepared For FCRC	
Designed by P. Gallagher	Checked by	Filename Shryver Pond_v1.SKF	Date June 11, 2009
Fin-Up Habitat Consultants, Inc. 220 Illinois Ave. Manitou Springs, CO 80829 (719) 332-2550		As Built - Shryver Pond Restoration Plan - Shryver Park	
Plan Drawing #4		Edition Ver. 1.0	Sheet 1



REVISIONS				
ZONE	REV	DESCRIPTION	DATE	APPROVED

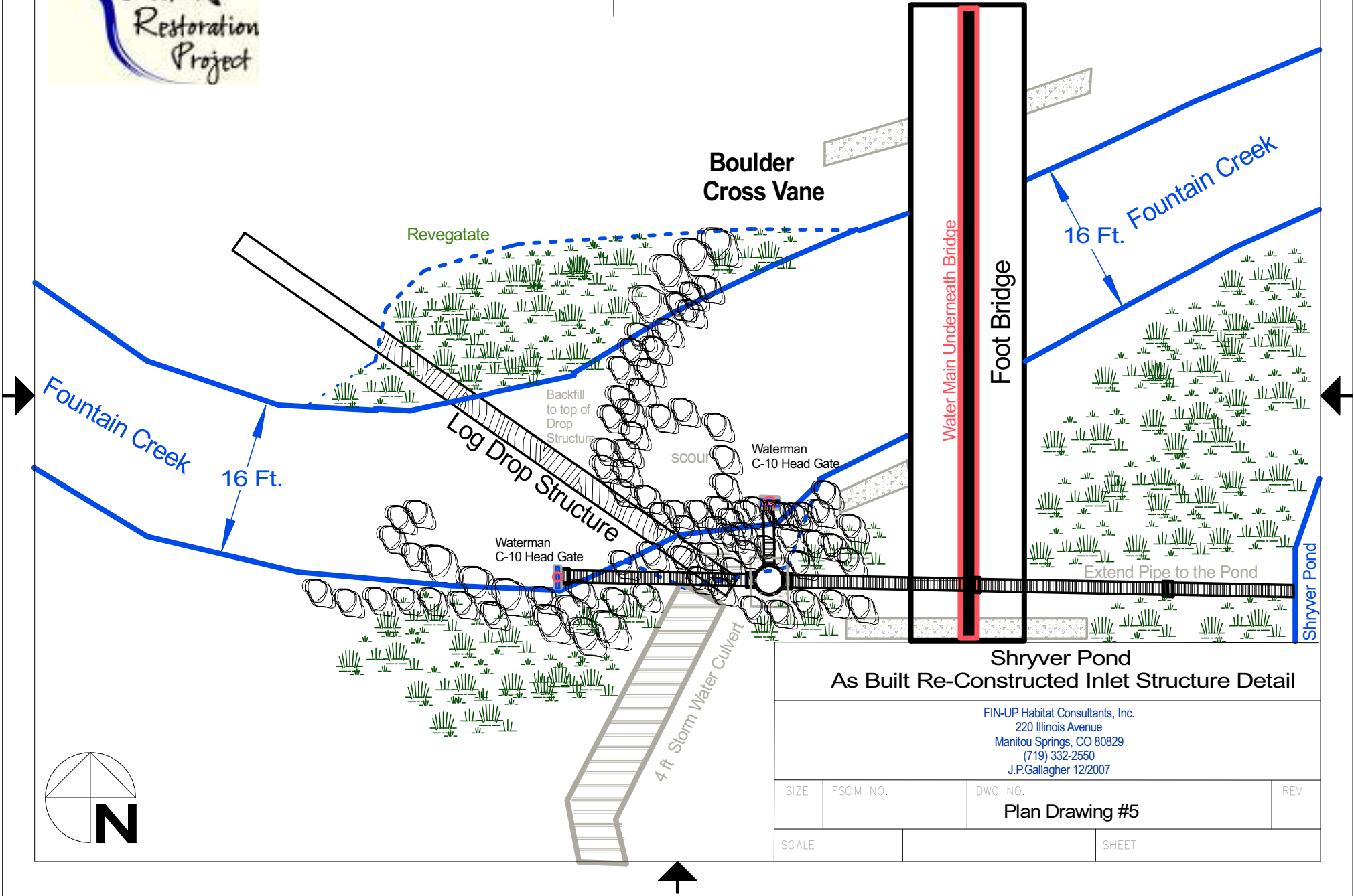

**Shryver Pond
As Built Re-Constructed Inlet Structure Detail**

FIN-UP Habitat Consultants, Inc.
220 Illinois Avenue
Manitou Springs, CO 80829
(719) 332-2550
J.P.Gallagher 12/2007

SIZE	FSCM NO.	DWG NO.	REV
SCALE			SHEET

Plan Drawing #5

Inlet Works Profile View

REVISIONS				
ZONE	REV	DESCRIPTION	DATE	APPROVED

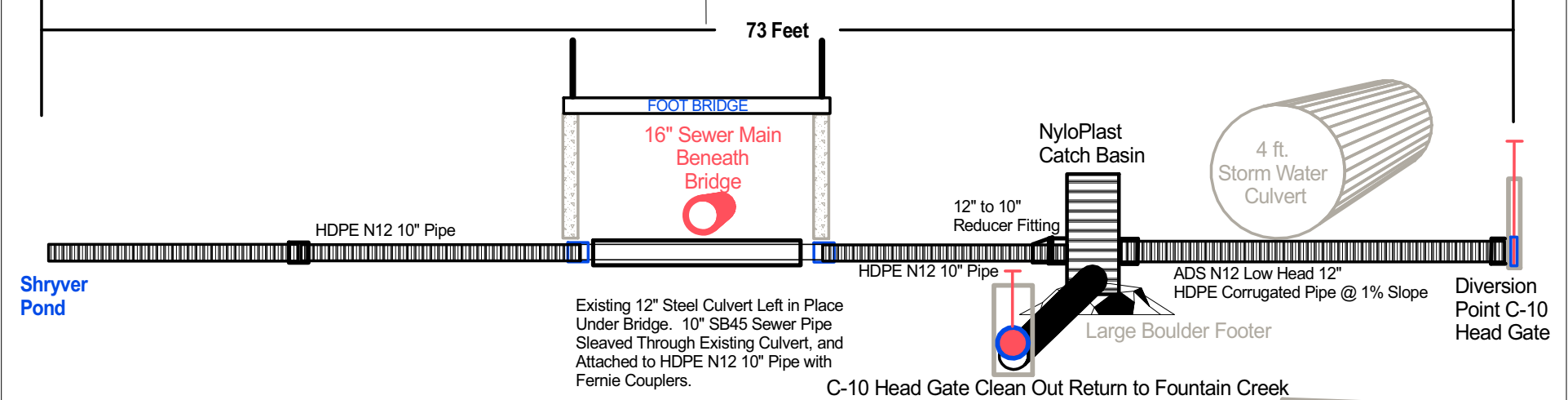

Inlet Works Plan View

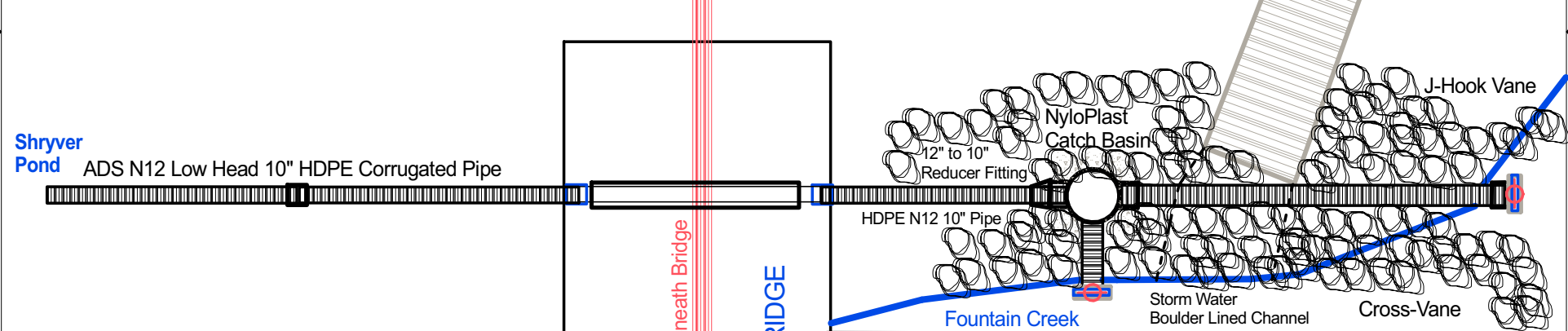

Stryver Pond As Built Inlet Structure Detail

FIN-UP Habitat Consultants, Inc.
 220 Illinois Avenue
 Manitou Springs, CO 80829
 (719) 332-2550
 J.P.Gallagher 06/2009



SIZE	FSCM NO.	DWG NO.	REV
Plan Drawing #6			
SCALE	SHEET		

1	2	3	4
RevNo	Revision note	Date	Signature
			Checked

TOP VIEW

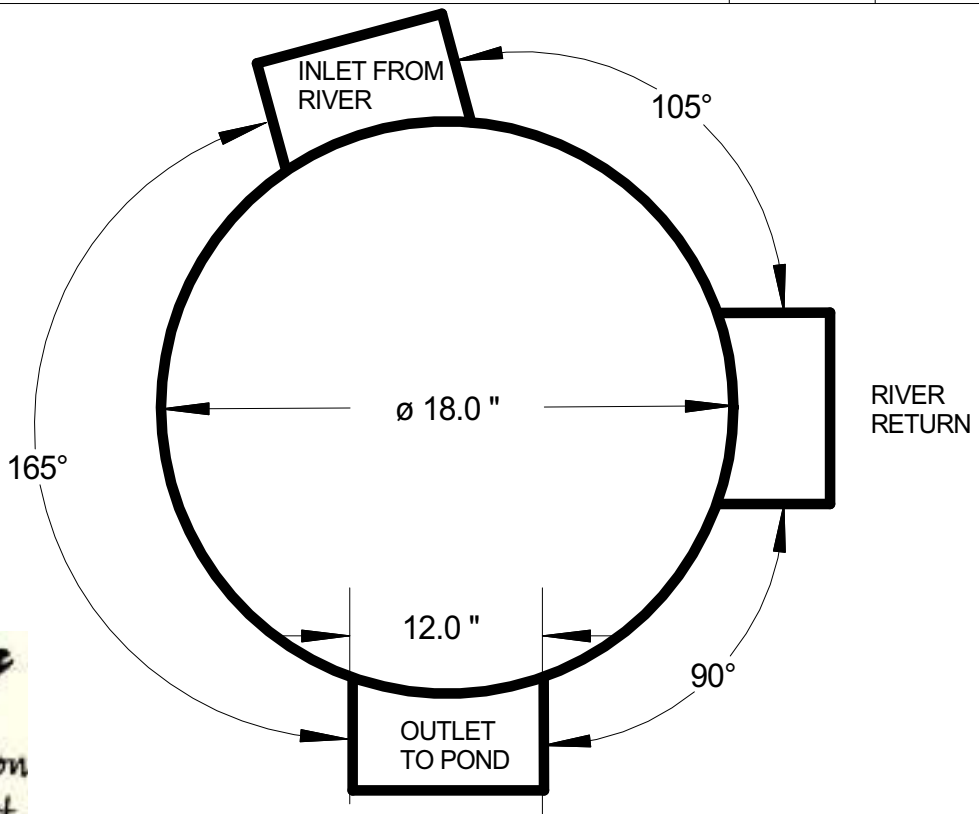

SIDE VIEW

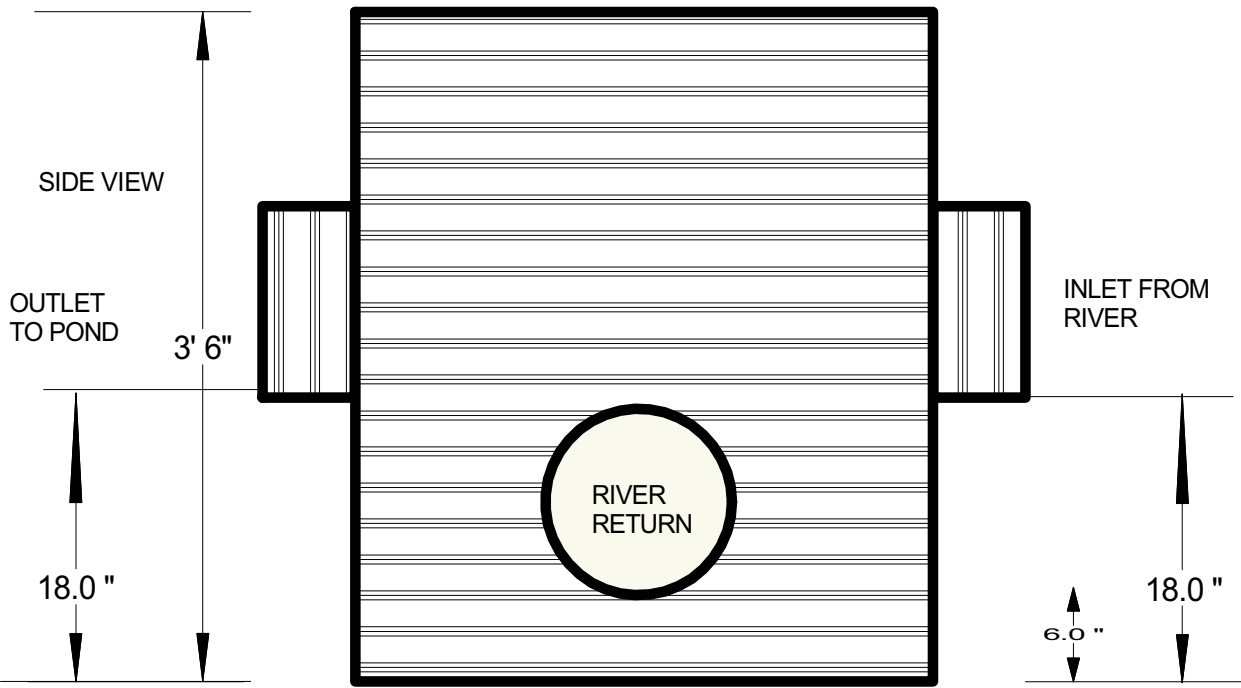

SHRYVER POND INLET CATCH BASIN PLAN & PROFILE			Prepared For FCRC/Manitou Spgs	
Designed by P. Gallagher	Checked by	Filename CATCH_BASIN.SKF	Date Feb. 17, 2009	Scale 1" = 1.0 Ft.
Fin-Up Habitat Consultants, Inc. 220 Illinois Ave. Manitou Springs, CO 80829 (719) 332-2550			FOUNTAIN CREEK REACH 4 - SHRYVER POND	
Plan Drawing #7			Edition Ver. 1.0	Sheet 1

Drawings of Treatment Types

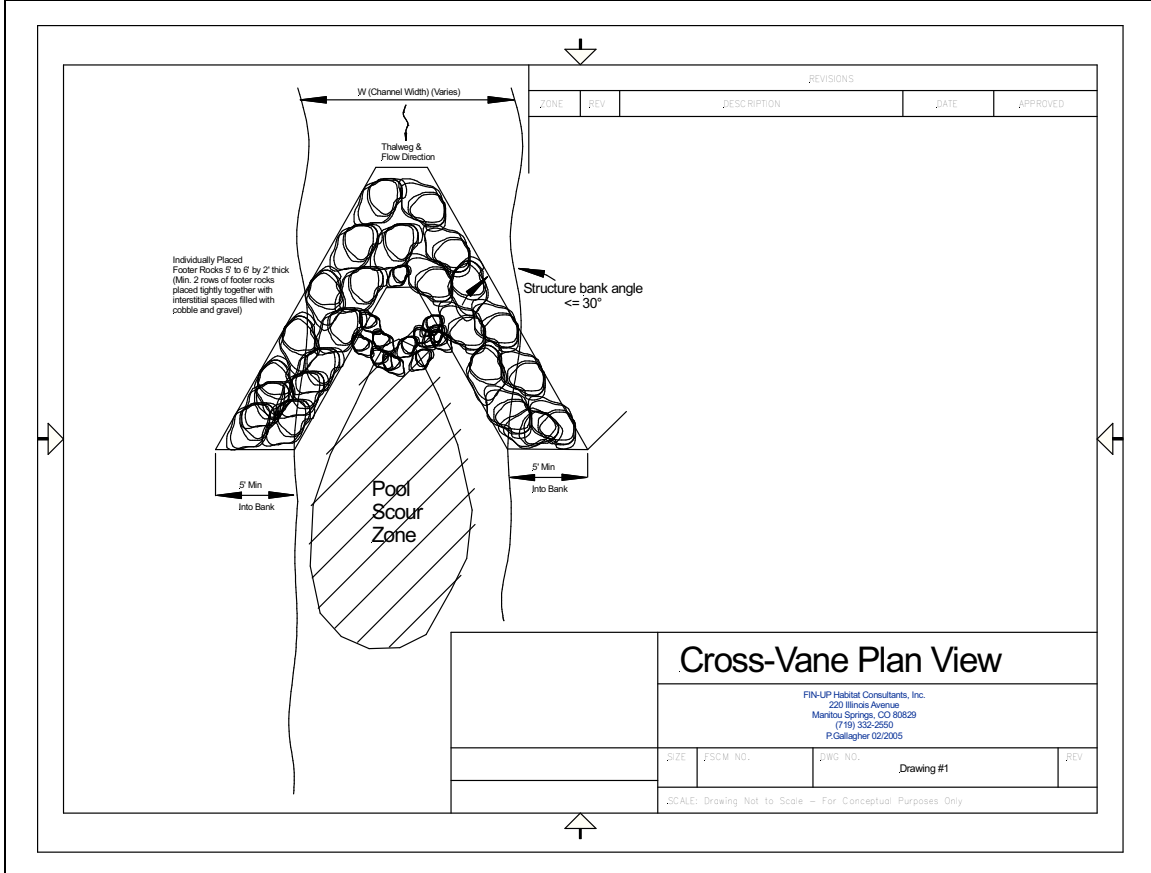
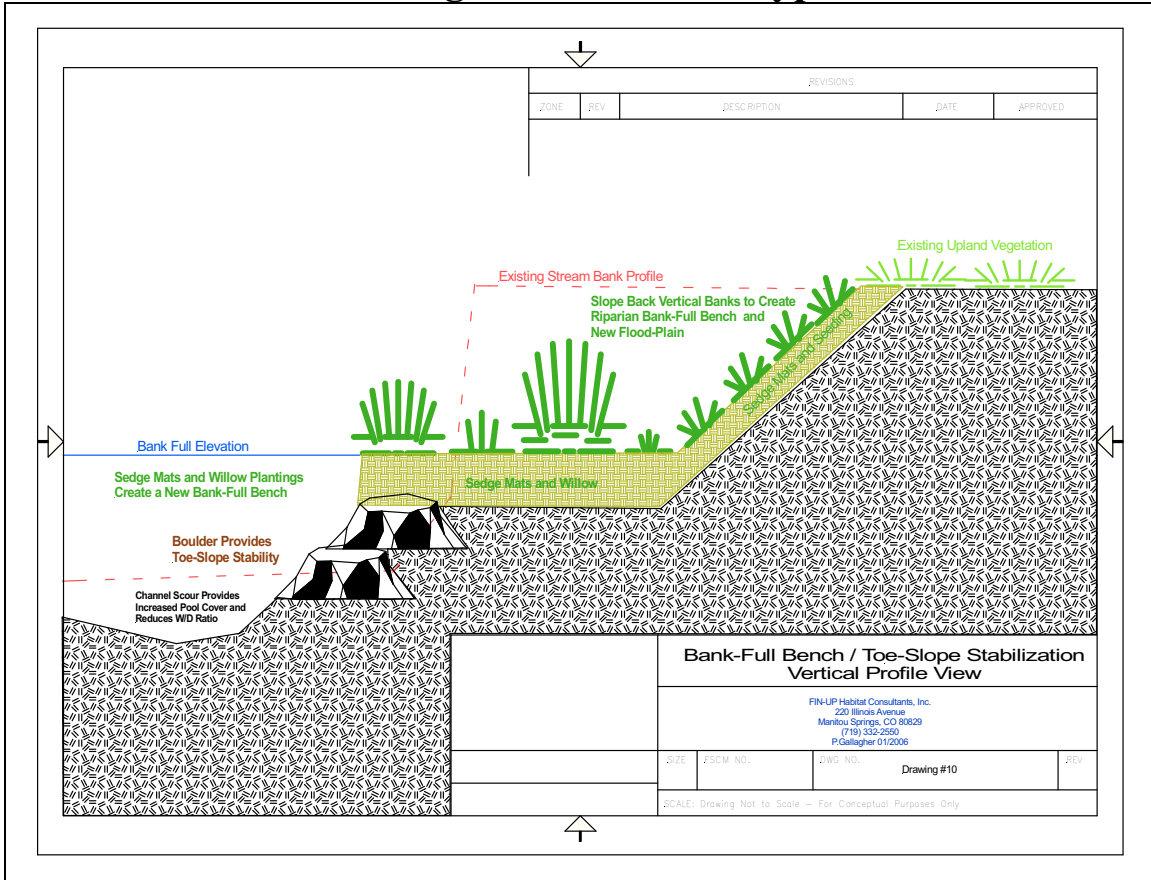

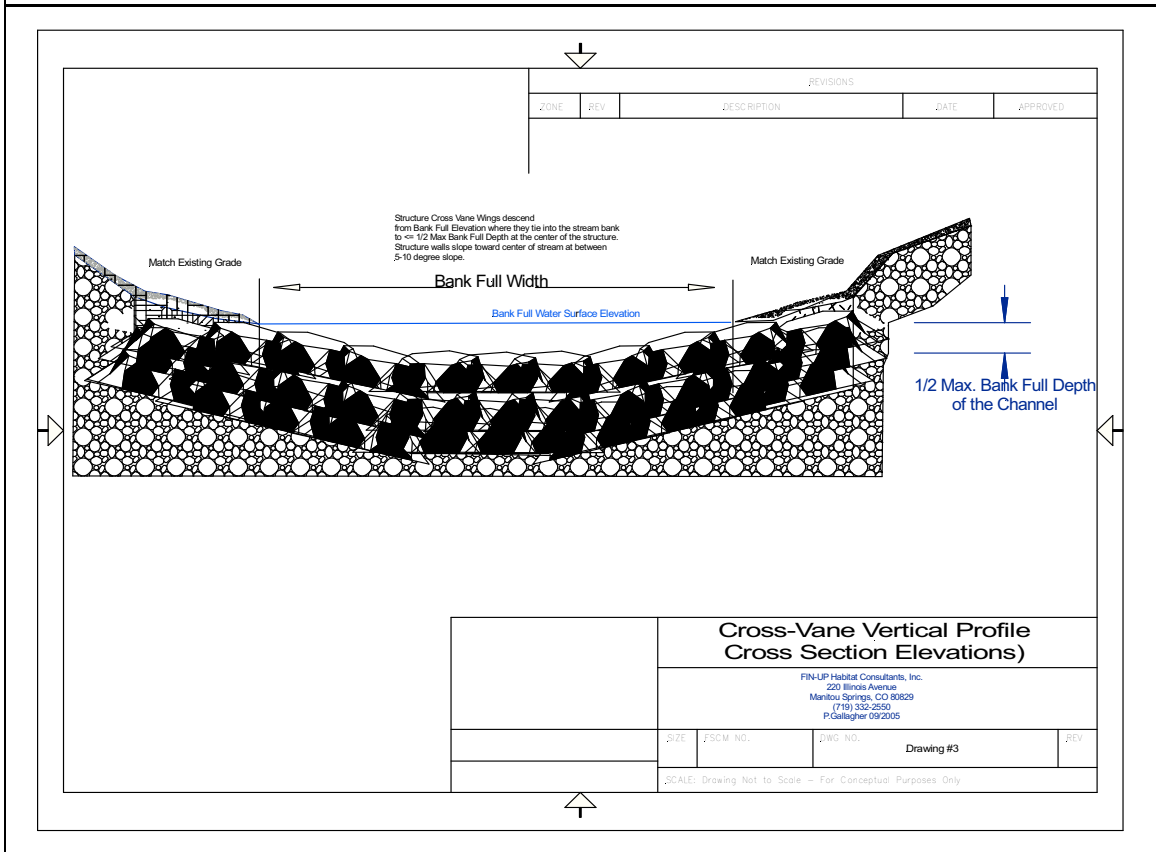
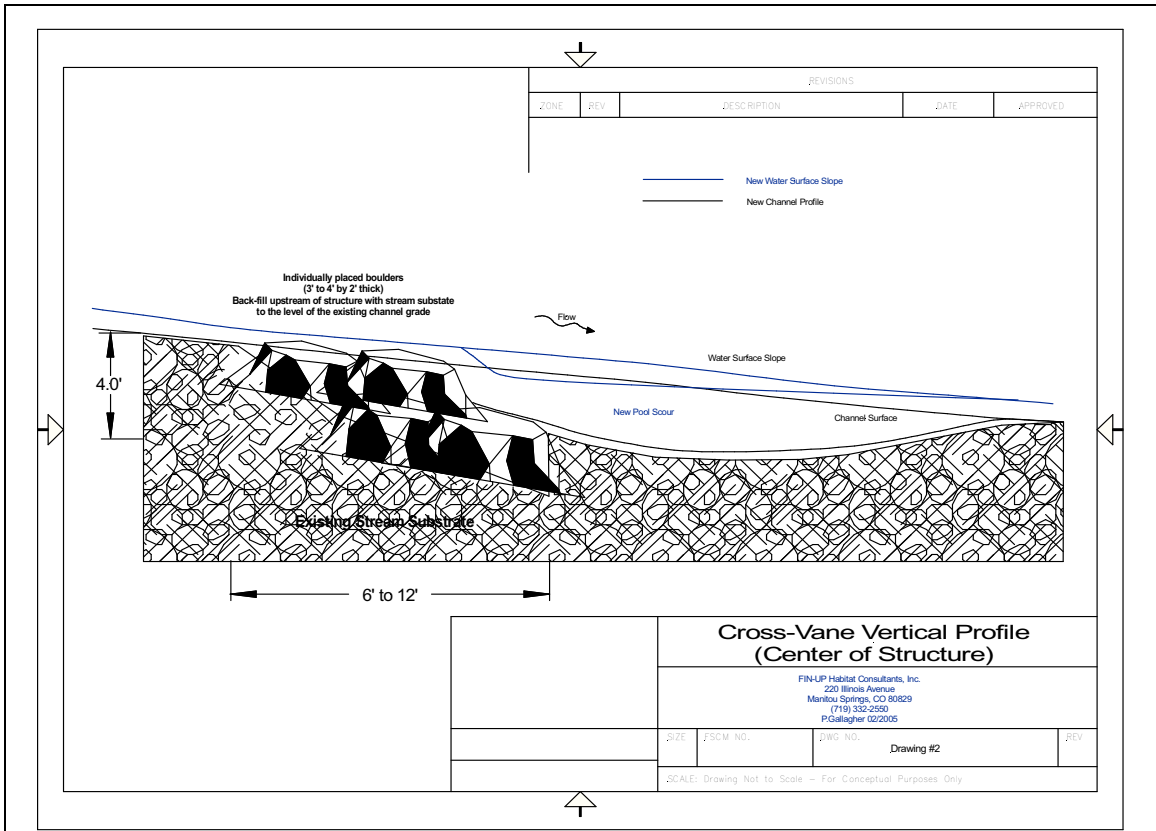

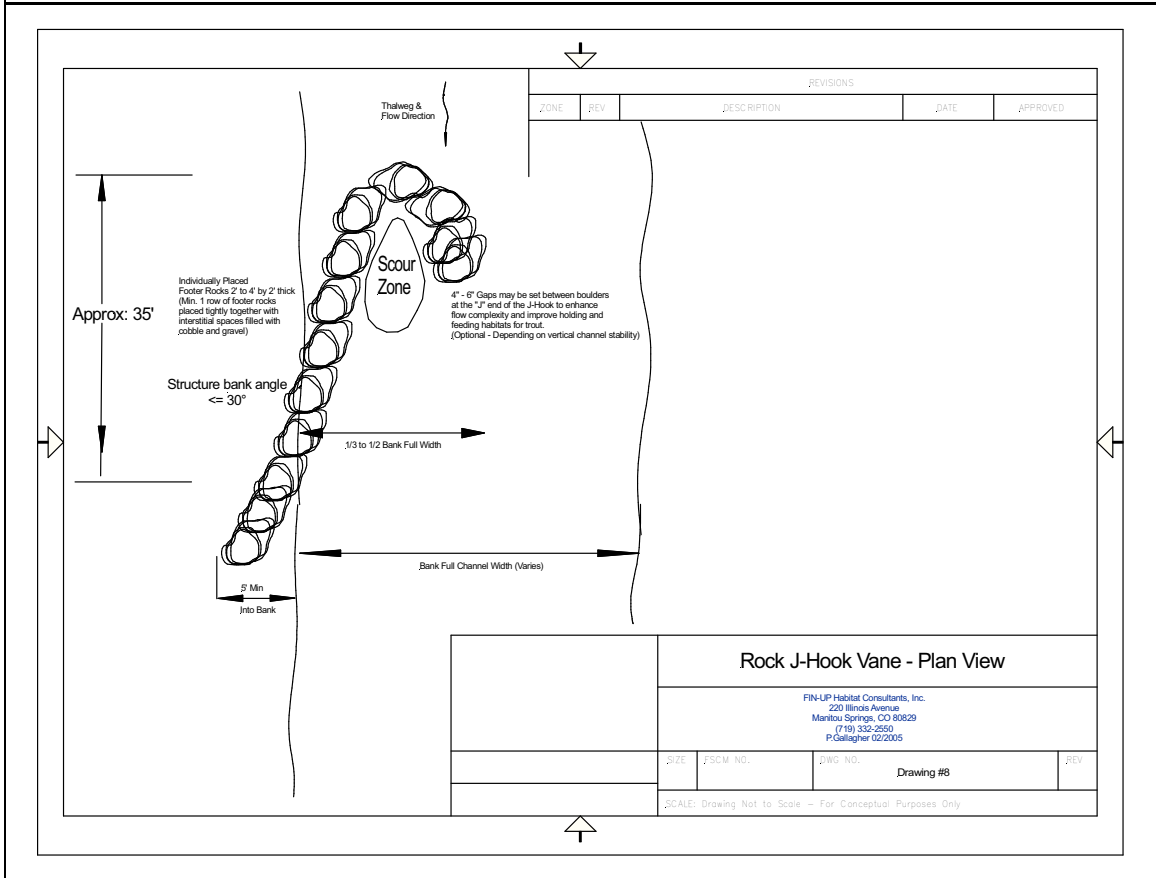
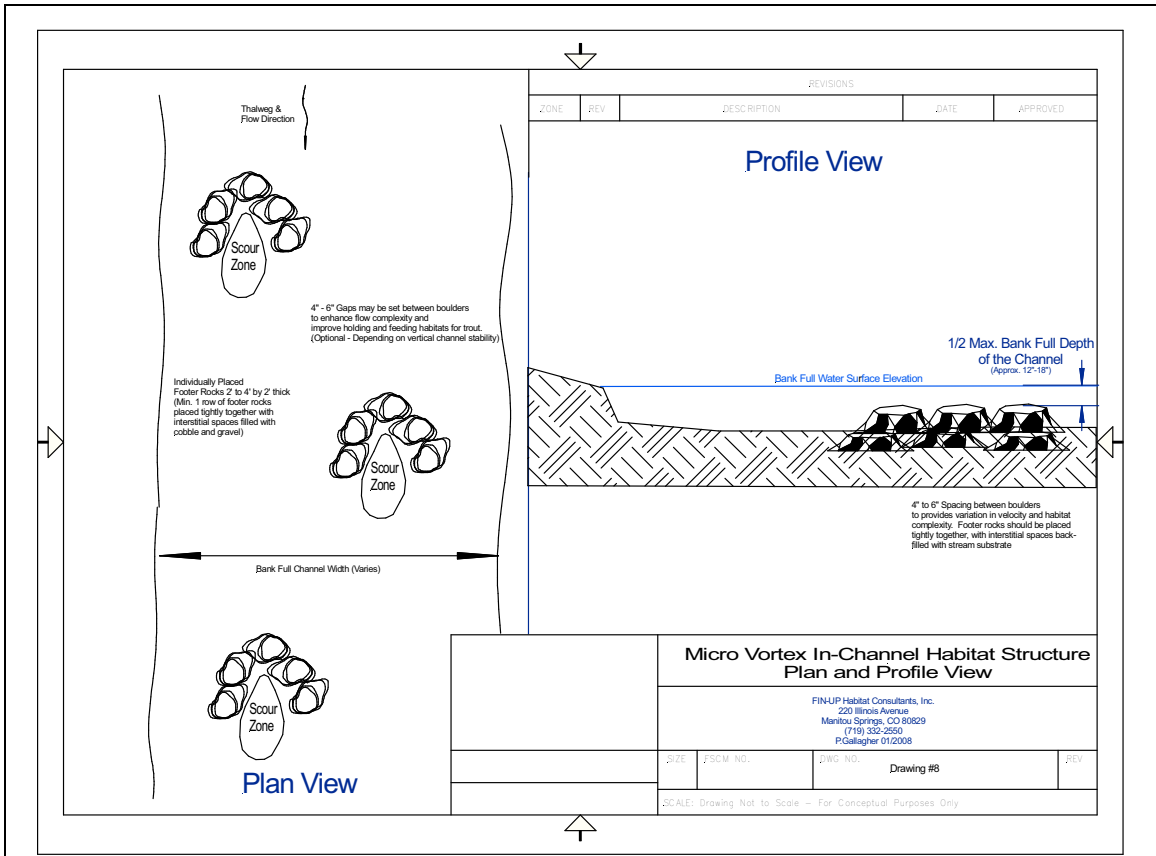

PLANS FOR CONSTRUCTION SCHRYVER PARK FOOT BRIDGE PROJECT MANITOU SPRINGS, CO

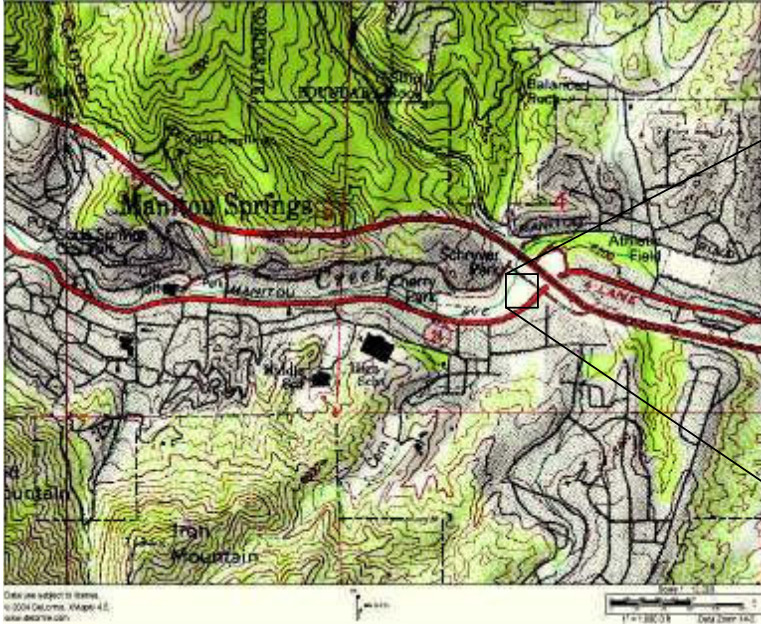

VICINITY MAP
SCALE: 1" = 1000'

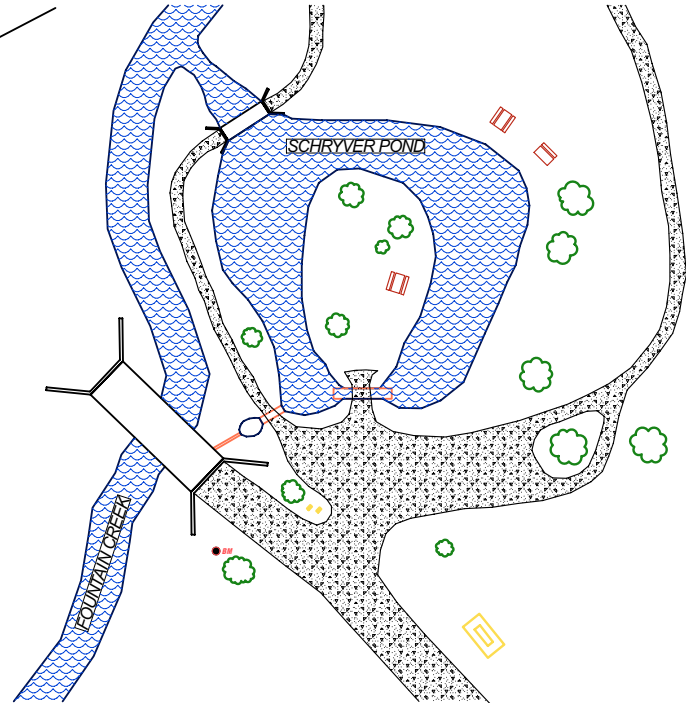

SITE MAP
NO SCALE



SHEET LIST

SHEET NUMBER	SHEET TITLE
1	COVER SHEET
2	SITE PLAN
3	BRIDGE PLAN
4	BRIDGE SECTION
5	BRIDGE ABUTMENT AND WING WALL PLANS AND DETAILS
6	BRIDGE BEAM, DECK & HANDRAIL SECTIONS AND NOTES
7	MISCELLANEOUS DETAILS AND NOTES

I, WILLIAM T. MCCORMICK, III, A REGISTERED PROFESSIONAL ENGINEER IN THE STATE OF COLORADO, HEREBY CERTIFY THAT THESE PLANS AND SPECIFICATIONS WERE PREPARED BY ME OR WERE PREPARED UNDER MY DIRECT SUPERVISION FOR THE OWNERS THEREOF.

BY: WILLIAM T. MCCORMICK, III, P.E. NO. 29127

CONCRETE COUCH
211 ILLINOIS AVENUE, MANITOU SPRINGS, CO 80829
WWW.CONCRETECOUCH.ORG

GIUSTI DESIGN
ENGINEERING DIVISION
2615 LOGAN CIRCLE
COLO SPGS, CO 80907
PH: 719.635.1115

PROJECT NO. 0000001
APRIL, 2009

SHEET 1 OF 7

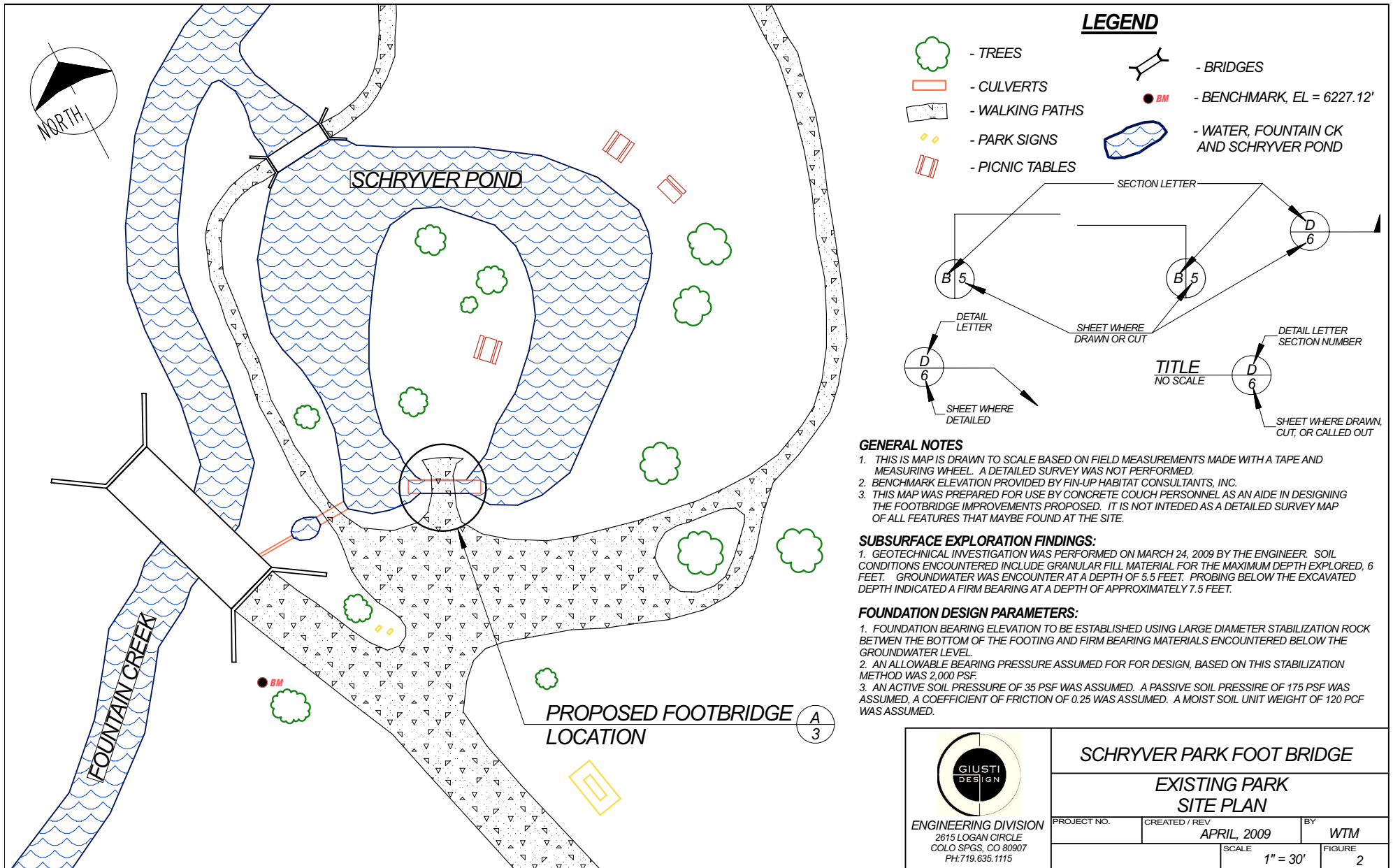

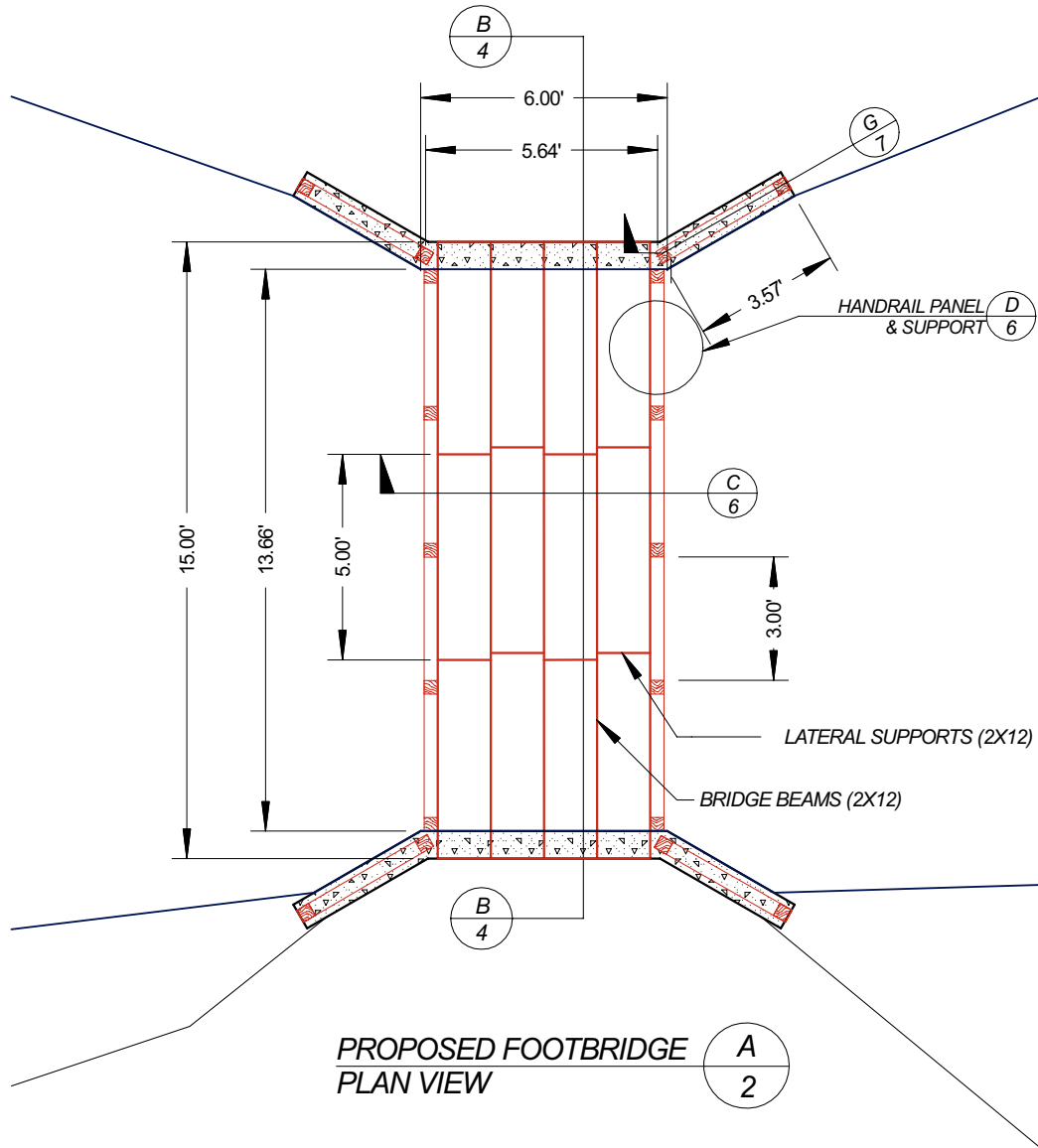

STRUCTURAL DESIGN PARAMETERS:

1. THE DESIGN OF THE STRUCTUREAL COMPONENTS (BEAMS AND SUPPORTS) WAS PERFORMED IN GENERAL ACCORDANCE WITH THE "GUIDE SPECIFICATIONS FOR DESIGN OF PEDESTRIAN BRIDGES", AASHTO, AUGUST, 1997, AND "TIMBER BRIDGES: DESIGN CONSTRUCTION, INSPECTION AND MAINTENANCE", USFS ENGINEERING MANUAL 7700, 1990.
2. ALL STRUCTURAL COMPONENTS, BEAMS, AND LATERAL SUPPORTS SHALL BE CONSTRUCTION GRADE, ROUGH SAWN DOUGLAS FIR-LARCH WITH DIMENSIONS INDICATED.
3. ASSUMED ALLOWABLE EXTREME FIBER SHEAR STRESS IN BENDING, $F_b = 1050$ psi; $E = 1,500,000$ psi;
3. VERTICAL SUPPORTS FOR HANDRAIL SHALL BE ROUGH SAWN 4"X4" POSTS.

EXCAVATION AND BACKFILL REQUIREMENTS:

1. EXCAVATION FOR FOOTINGS AND WING WALLS WILL BE WITHIN EXISTING GRANULAR FILL MATEIRALS. GRANULAR MATERIAL IS RE-USEABLE PROVIDED ALL NATURAL AND MADE MADE MATERIALS LARGER THAN 3 INCHES IN THEIR LARGEST DIMENSION ARE REMOVED PRIOR TO PLACEMENT AND COMPACTION.
2. THE SUBGRAGE PREPARATION FOR FOUNDATIONS INCLUDES USE OF LARGE DIAMETER RIP RAP FOR STABILIZATION. A LEVELING COURSE OF COARSE GRANULAR MATERIAL SHOULD BE PROVIDED TO ENSURE UNIFORM BEARING OF THE FOOTING.
3. THE ENGINEER SHALL INSPECT THE EXCAVATION PRIOR TO CONCRETE FORM PLACEMENT TO VERIFY THE BEARING MATERIAL AND SUBGRADE PREPARATION.
4. THE FOUNDATION BEARING SURFACES SHALL BE KEPT AND STABLE UNTIL THE STRUCTURES ARE COMPLETE AND READY FOR BACKFILLING.
5. ALL BACKFILL AND COMPACTION SHALL BE PERFORMED TO MINIMIZE FUTURE SETTLEMENT.
6. GRANULAR BACKFILL MATERIAL SHALL BE PLACED IN LIFTS MATCHING THE LEVEL OF COMPACTIVE ENERGY UTILIZED. LOWER COMPACTIVE ENERGY METHODS SHALL UTILIZE THINNER LIFTS OF SUITABLE MATERIALS.

 ENGINEERING DIVISION 2615 LOGAN CIRCLE COLO SPGS, CO 80907 PH: 719.635.1115	SCHRYVER PARK FOOT BRIDGE		
	BRIDGE PLAN		
	PROJECT NO.	CREATED / REV	BY
	APRIL, 2009	WTM	
	SCALE	FIGURE	
	AS SHOWN	3	

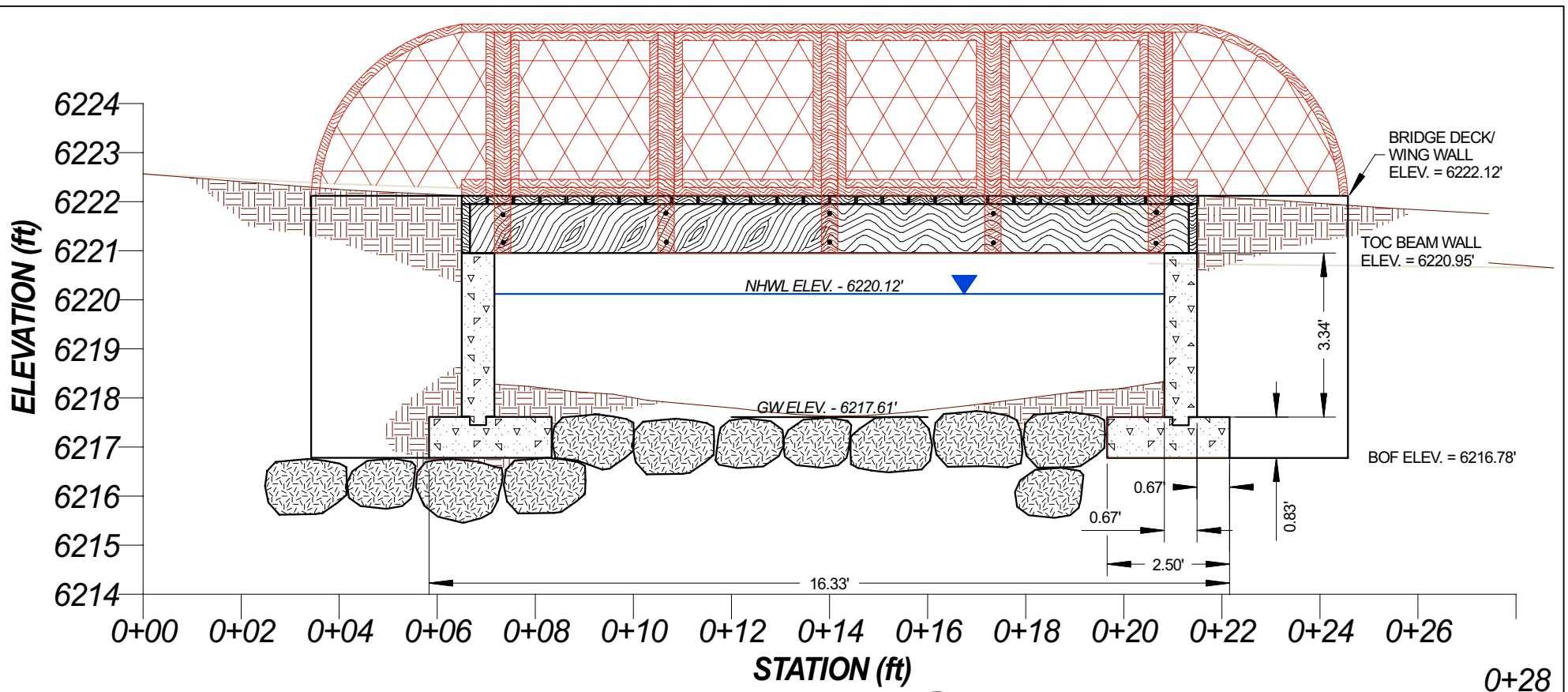

NOTES

1. WING WALL FOOTING PREPARATION INCLUDES INSERTING BOULDERS BENEATH FOOTING AREA UNTIL BACKHOE REFUSAL TO ADDITIONAL INSERTION IS ACHIEVED.
2. FINAL ELEVATION OF BOULDERS USED BENEATH FOOTINGS SHOULD BE AT OR SLIGHTLY BELOW BOTTOM OF FOOTING (BOF) ELEVATION SHOWN.
3. AREA BENEATH FOOTINGS TO BE LEVELED USING CRUSHED ROCK FINES OR GRANULAR MATERIAL TO PROVIDE A LEVEL SURFACE FOR FOOTING CONSTRUCTION AT THE BOF ELEVATION SHOWN.
4. REBAR NOT SHOWN IN FOOTING OR WALLS FOR CLARITY. SEE SHEET 5 FOR DETAILS.
5. MAXIMUM CLEAR SPACE OPENING IN ALL ELEMENTS IN HANDRAIL PANELS SHALL BE 4 INCHES. A 4-INCH BALL SHALL NOT PASS THROUGH ANY SPACES IN THE RAILING.

BRIDGE SECTION
NO SCALE

B
3

ABBREVIATIONS

- BOF** - BOTTOM OF FOOTING
- ELEV** - ELEVATION ABOVE SEA LEVEL (FEET)
- GW** - GROUNDWATER
- NHWL** - NORMAL HIGH WATER LINE
- TOC** - TOP OF CONCRETE

 ENGINEERING DIVISION 2615 LOGAN CIRCLE COLO SPGS, CO 80907 PH: 719.635.1115	SCHRYVER PARK FOOT BRIDGE		
	BRIDGE SECTION		
	PROJECT NO.	CREATED / REV APRIL, 2009	BY WTM
SCALE AS SHOWN		FIGURE 4	

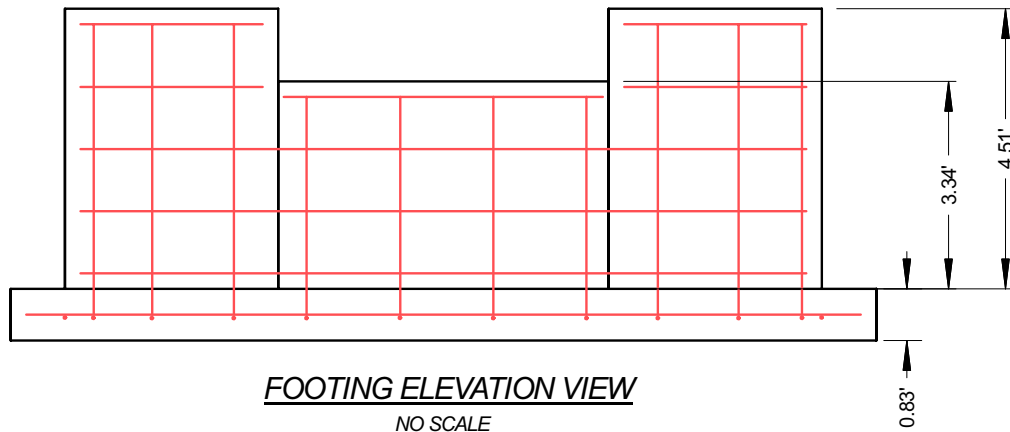
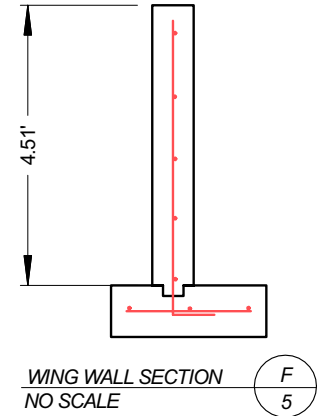
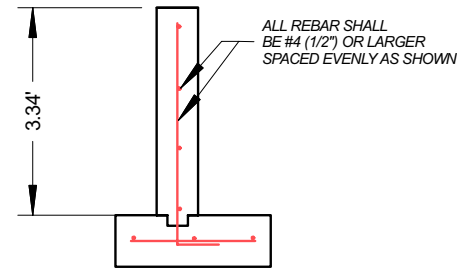
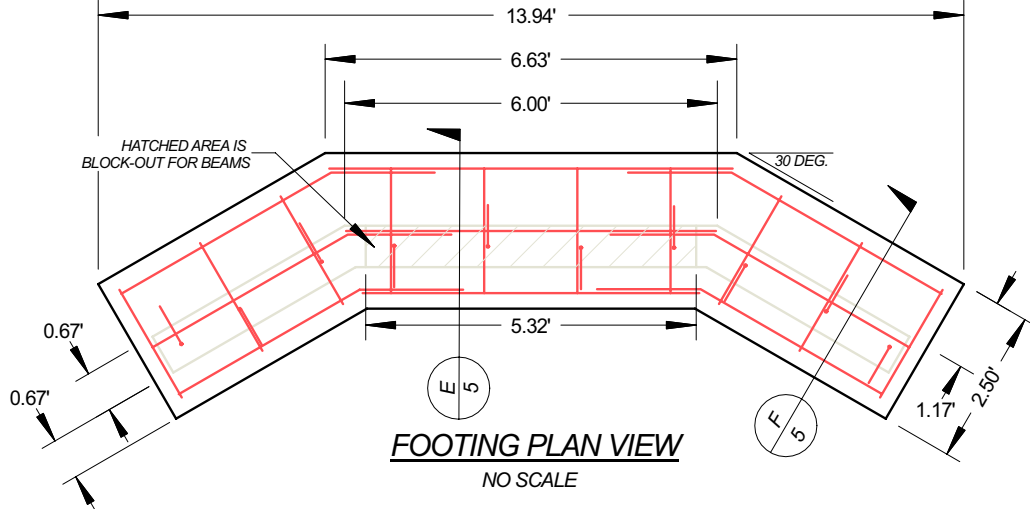

CONCRETE REINFORCEMENT:

1. DESIGN, DETAILING, FABRICATION AND INSTALLATION OF REINFORCEMENT SHALL BE IN ACCORDANCE WITH ACI CODE AND MANUALS, ACI 318-99.
2. STEEL REINFORCEMENT SHALL BE NEW, DEFORMED BILLET STEEL MEETING ASTM STANDARD A615, LATEST REVISION. ALL REBAR SHALL BE MINIMUM GRADE 40. ALL REBAR SHALL BE #4 OR LARGER.
3. REINFORCEMENT IN ALL STEM WALLS SHALL BE CONTINUOUS AROUND CORNERS OR CORNER BARS SHALL BE PROVIDED.
4. DIRECTION OF TAILS ON HOOKS ON VERTICAL BARS SHOULD BE ALTERNATED AS SHOWN.
5. LAP ALL HORIZONTAL SPLICES A MINIMUM 40 BAR DIAMETERS (20").
6. PROVIDE CONCRETE PROTECTION FOR REINFORCEMENT AS FOLLOWS:
 1. CONCRETE POURED AGAINST EARTH.....3"
 2. CONCRETE POURED IN FORMS BUT EXPOSED TO GROUND OR WEATHER.....2"
7. PROVIDE GALVANIZED OR PLACTIC-FOOTED ACCESSORIES FOR ALL CONCRETE SURFACES EXPOSED TO WEATHER OR VIEW.
8. TACK WELDING OR WELDING OF REINFORCEMENT SHALL NOT BE PERMITTED. ALL REINFORCING SHALL BE COLD BENT AND TIED SECURELY IN PLACE.

CONCRETE:

1. DESIGN AND CONSTRUCTION SHALL BE IN ACCORDANCE WITH ACI BUILDING CODE (ACI-318-99).
2. CEMENT SHALL BE TYPE II PORTLAND CEMENT CONFORMING TO ASTM C150, LATEST EDITION.
3. CONCRETE SHALL DEVELOP A MINIMUM COMPRESSIVE STRENGTH OF 3,000 PSI WITHIN 28 DAYS OF PLACEMENT.
4. CONCRETE SHALL HAVE A SLUMP IN THE RANGE OF 4-6 INCHES.
5. CONCRETE SHALL HAVE AIR-ENTRAINMENT IN THE RANGE OF 5-7% BY VOLUME.

 ENGINEERING DIVISION 2615 LOGAN CIRCLE COLO SPGS, CO 80907 PH:719.635.1115	SCHRYVER PARK FOOT BRIDGE		
	ABUTMENT AND WING WALL PLANS AND DETAILS		
	PROJECT NO.	CREATED / REV APRIL, 2009	BY WTM
	SCALE AS SHOWN	FIGURE 5	

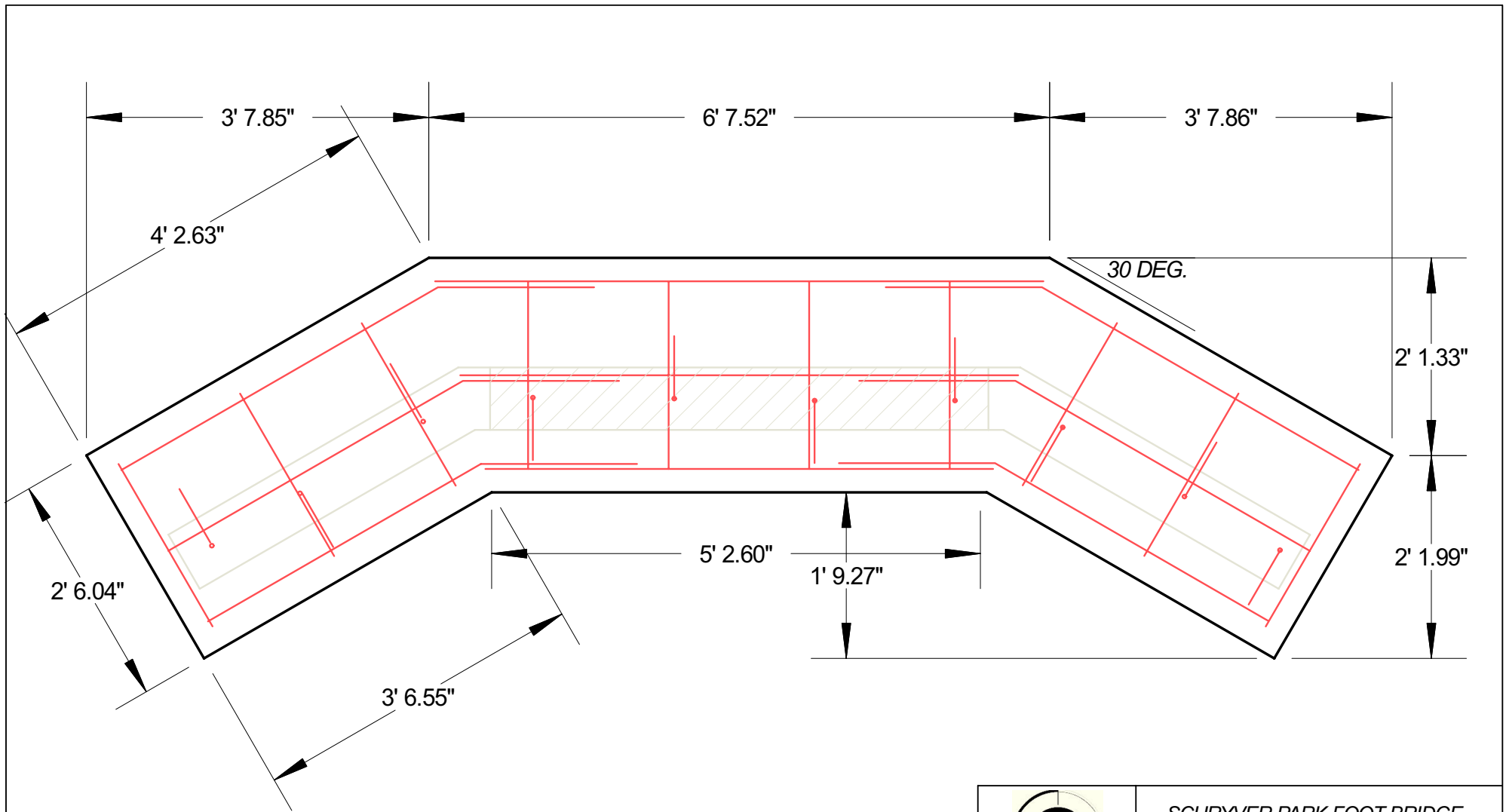

 <p>ENGINEERING DIVISION 2615 LOGAN CIRCLE COLO SPGS, CO 80907 PH: 719.635.1115</p>	SCHRYVER PARK FOOT BRIDGE		
	FOOTING DIMENSIONS <i>for STEVE & PETE</i>		
	PROJECT NO.	CREATED / REV	BY
		APRIL, 2009	WTM
	SCALE	FIGURE	
	AS SHOWN	5	

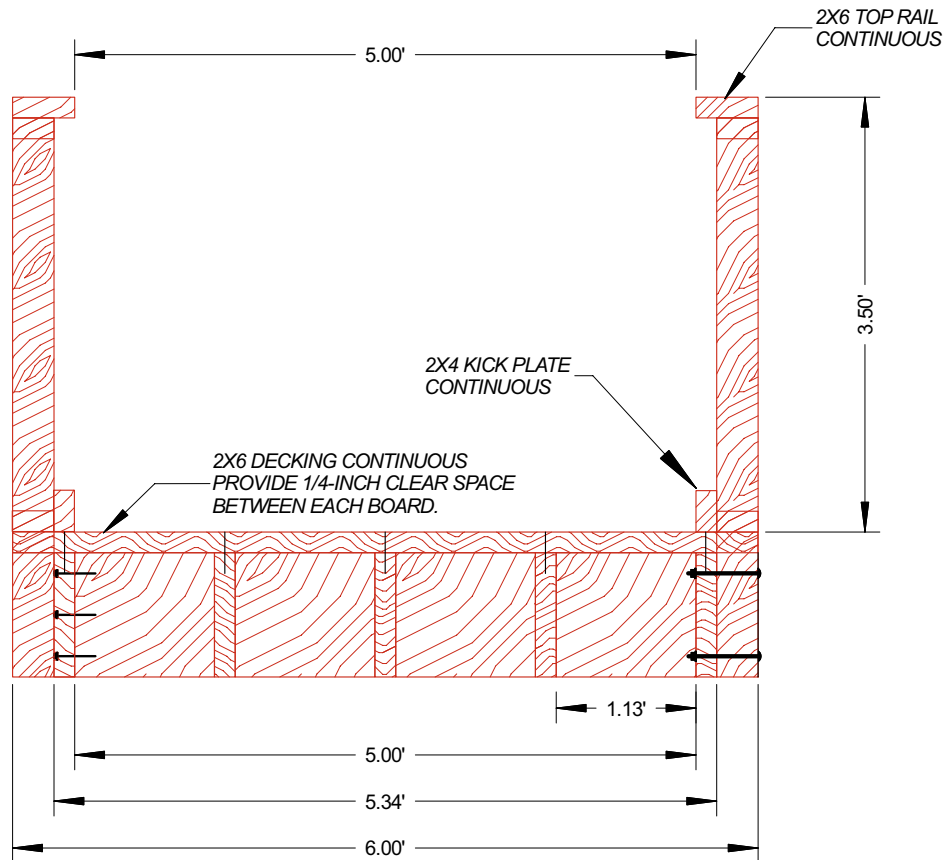

**FOOTBRIDGE
SECTION VIEW**

C
3

FASTENERS:

1. ALL FASTENERS TO JOIN 2X12 BEAMS AND LATERAL SUPPORTS SHALL BE 4-INCH LONG BY 1/4-INCH GALVANIZED LAG BOLTS. LAG BOLTS SHALL BE COUNTER SUNK TO THE DEPTH OF THE BOLT HEAD PLUS A SUITABLE WASHER. 3 BOLTS SHALL BE PROVIDED FOR EACH LATERAL SUPPORT CONNECTION SPACED AS SHOWN.
2. FASTENERS TO ATTACH HANDRAIL POSTS TO THE OUTSIDE BRIDGE BEAMS SHALL BE 7-INCH LONG 3/8-INCH DIAMETER GALVANIZED CARRIAGE BOLTS. THREADED END OF CONNECTION SHALL BE ON THE INSIDE OF THE BEAM AS SHOWN.
3. FASTENERS TO ATTACH TOP HANDRAIL TO HANDRAIL POSTS SHALL BE 4-INCH LONG BY 1/4-INCH GALVANIZED LAG BOLTS. LAG BOLTS SHALL BE COUNTER SUNK TO THE DEPTH OF THE BOLT HEAD PLUS A SUITABLE WASHER. 2 BOLTS SHALL BE PROVIDED FOR EACH TOPRAIL CONNECTION SPACED AS SHOWN.

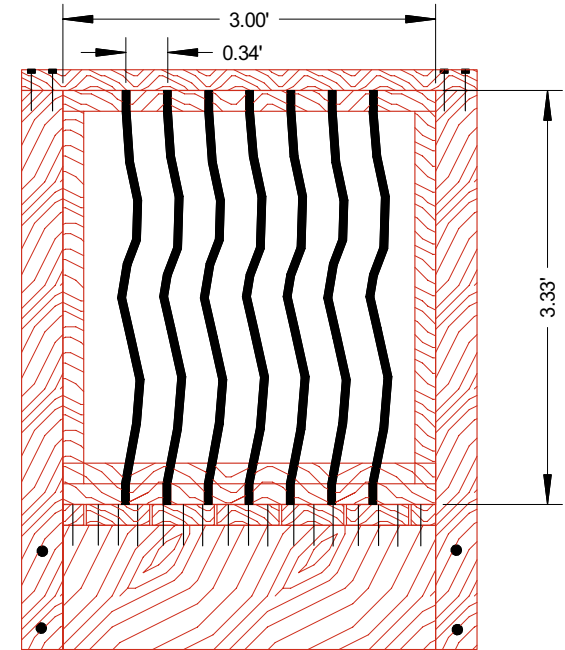

**HANDRAIL PANEL
& SUPPORT DETAIL**

D
3

ARCHITECTURAL/ARTISTIC FEATURES:

1. HANDRAIL PANELS SHALL BE CONSTRUCTED TO THE SATISFACTION OF THE ENGINEER.
2. ALL ARCHITECTURAL AND ARTISTIC FEATURES WITHIN THE PANELS SHALL BE ADEQUATELY CONNECTED TO PREVENT LOOSENING OR DAMAGE WITH TIME AND PUBLIC USE.
3. CLEAR SPACE BETWEEN ARCHITECTURAL AND ARTISTIC FEATURES SHALL BE NOT MORE THAN 4 INCHES.

 ENGINEERING DIVISION 2615 LOGAN CIRCLE COLO SPGS, CO 80907 PH: 719.635.1115	SCHRYVER PARK FOOT BRIDGE		
	BRIDGE BEAMS, DECK & RAILING SECTIONS AND DETAILS		
	PROJECT NO.	CREATED / REV APRIL, 2009	BY WTM
	SCALE AS SHOWN	FIGURE 6	

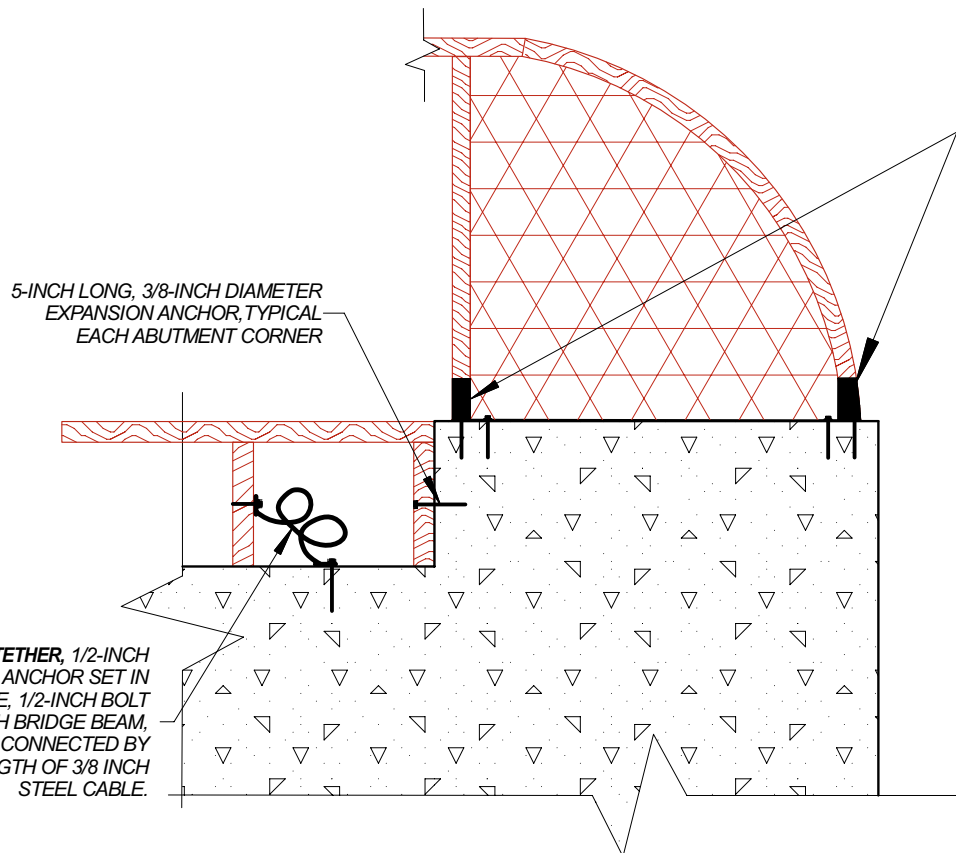

HANDRAIL BASE SUPPORTS:
 PROVIDE SUITABLE SUPPORT FOR POSTS,
 ANCHOR USING 3, 4-INCH-LONG, 3/8-INCH
 EXPANSION ANCHORS.

5-INCH LONG, 3/8-INCH DIAMETER
 EXPANSION ANCHOR, TYPICAL
 EACH ABUTMENT CORNER

**BRIDGE TETHER, 1/2-INCH
 EXPANSION ANCHOR SET IN
 CONCRETE, 1/2-INCH BOLT
 THROUGH BRIDGE BEAM,
 BOLTS CONNECTED BY
 6-FOOT LENGTH OF 3/8 INCH
 STEEL CABLE.**

HANDRAIL SUPPORT (G)
ON CONCRETE 3

FASTENERS (CONTINUED):

4. ALL 2X6 DECKING SHALL BE ATTACHED TO BEAMS USING 4-INCH LONG DECK SCREWS COATED FOR EXTERIOR USE AND PROVIDED WITH WITH STAR (TORX) HEADS. EACH CONNECTION SHALL BE PROVIDED WITH 3 EVENLY SPACED SCREWS IN A LINE ALONG THE CENTER OF EACH BEAM.
5. FASTENERS TO ATTACH HANDRAIL PANEL FRAMES TO THE DECK, POSTS AND TOP RAIL SHALL BE 3-1/2-INCH COATED DECK SCREWS SUITABLE FOR OUTSIDE USE AND PROVIDED WITH WITH STAR (TORX) HEADS.
5. **PREDRILLING IS REQUIRED FOR ALL FASTENERS. CARRIAGE BOLTS SHALL BE PREDRILLED TO THE SPECIFIED BOLT DIAMETER. LAG BOLTS AND DECK SCREWS SHALL BE PREDRILLED USING A DRILL BIT 1/2 OF THE BOLT OR SCREW DIAMETER SPECIFIED.**

WOOD PRESERVATION AND FINISHING:

1. ALL WOOD USED ON THE PROJECT MUST BE TREATED WITH A COMMERCIALY AVAILABLE WOOD PRESERVATIVE SUITABLE FOR USE IN A SETTING WHERE HUMAN CONTACT IS EXPECTED.
2. ALL WOOD SHOULD BE COATED WITH THE PRESERVATIVE PRIOR TO BEING INSTALLED. ALL FASTENER HOLES SHOULD BE COATED WITH THE PRESERVATIVE FOLLOWING ALL BOLT AND SCREW INSTALLATIONS
3. ALL HANDRAIL SURFACES SHOULD BE SANDED FOLLOING INSTALLATION TO REDUCE THE POTENTIAL FOR ROUGH EDGES AND SPLINTERING.
4. ALL ARCHITECTURAL AND ARTISTIC ELEMENTS HOULD BE CHECKED FOR ROUGH EDGES PRIPR TO INSTALLATION. ALL ROUGH EDGES SHALL BE GROUND SMOOTH OR OTHERWISE ROUNDED.

 ENGINEERING DIVISION 2615 LOGAN CIRCLE COLO SPGS, CO 80907 PH: 719.635.1115	SCHRYVER PARK FOOT BRIDGE		
	MISCELLANEOUS DETAILS & NOTES		
	PROJECT NO.	CREATED / REV APRIL, 2009	BY WTM
last revised APRIL 18, 2009		SCALE NO SCALE	FIGURE 7

Fountain Creek Reach 4
Shryver Park Reach & Pond Restoration Project
Post Project Residual Pool Depth Measurements

June 8, 2009

Colorado College Watershed Sciences Class

Participants: Ian, Molly, Lauren, Kaitlen, & Dana

Pool No.	Max Pool Depth (ft)	Pool Tail Depth (ft)	RPD (ft)
P1	1.40	1.00	0.40
P2	2.10	1.30	0.80
P3	2.00	0.95	1.05
P4	1.30	0.80	0.50
P5	1.30	0.90	0.40
P6	2.00	0.90	1.10
P7	2.70	1.00	1.70
P8	2.00	1.30	0.70
P9	1.50	1.30	0.20
P10	1.20	0.80	0.40
P11	2.00	0.90	1.10
P12	2.00	1.00	1.00
P13	1.90	0.80	1.10
P14	1.50	0.90	0.60

Shryver Park Reach and Pond Restoration Project

Heavy Construction Phase Photos



Shryver Park Reach and Pond Restoration Project

Revegetation and Volunteer Workdays
Rocky Mountain Field Institute

Photos



Shryver Park Reach and Pond Restoration Project

Shryver Pond Foot Bridge Construction Concrete Couch

Photos



Shryver Park Reach and Pond Restoration Project

Post Project Events

Annual “Huck-Finn” Day Fishing Derby at Shryver Pond

Photos



